



VERPAN

PREMIUM DESIGN

ΕΛ.ΕΜ.ΑΝΤΩΝΙΟΥ

ΚΟΥΦΩΜΑΤΑ ΑΛΟΥΜΙΝΙΟΥ-ΣΥΝΘΕΤΙΚΑ

ΠΑΡΑΔΟΣΙΑΚΑ ΠΑΚΕΤΑ

| ALU DOORS |

CATALOGUE _ V01



VERPAN

PREMIUM DESIGN

VERPAN is a family owned company. We are producing Entrance doors as well as door panels and interior doors. Our products are widely spread around the world.

Your entrance door at a glance

Entrance door is not only an element you need, it's the element that defines you.

It's the element that defines your personality, your love and your concern for your home. It's the element that provides you with safety and warmth.

We produce high - quality durable entrance doors

We make high quality entrance doors from aluminum combined with stainless steel and glass, in various designs, across different styles, in all Price ranges.

Our primary goal is to produce high quality products.

Our top priority is the satisfaction of our customers.

Follow your style with our high - quality entrance doors.

ΕΛΕΜ ΑΝΤΩΝΙΟΥ
ΚΟΥΦΩΜΑΤΑ ΑΛΟΥΜΙΝΙΟΥ-ΣΥΝΘΕΤΙΚΑ
ΠΑΡΑΔΟΣΙΑΚΑ ΚΑΓΚΕΛΑ



ΕΛ.ΕΜ. ΑΝΤΩΝΙΟΥ

ΚΟΥΦΩΜΑΤΑ ΑΛΟΥΜΙΝΙΟΥ-ΣΥΝΘΕΤΙΚΑ
ΠΑΡΑΔΟΣΙΑΚΑ ΚΑΓΚΕΛΑ

SUPERIOR 3DLINE

ΕΛ.ΕΜ. ΑΝΤΩΝΙΟΥ

ΚΟΥΦΩΜΑΤΑ ΑΛΟΥΜΙΝΙΟΥ-ΣΥΝΘΕΤΙΚΑ
ΠΑΡΑΔΟΣΙΑΚΑ ΚΑΓΚΕΛΑ



VERPAN
PREMIUM DESIGN

SUPERIOR 3DLINE

For some people one way is not enough!



They need more.
They need bright strength and luminous art.
They need a door like Superior 3d Entrance.

**SUPERIOR 3D
LINE**

ΕΛ.ΕΜ.ΑΝΤΩΝΙΟΥ
ΚΟΥΦΩΜΑΤΑ ΑΛΟΥΜΙΝΙΟΥ-ΣΥΝΘΕΤΙΚΑ
ΠΑΡΑΔΟΣΙΑΚΑ ΚΑΓΚΕΛΑ



V10100



V10201

ΕΛ.ΕΜ. ΑΝΤΩΝΙΟΥ

ΚΟΥΦΩΜΑΤΑ ΑΛΟΥΜΙΝΙΟΥ-ΣΥΝΘΕΤΙΚΑ
ΠΑΡΑΔΟΣΙΑΚΑ ΚΑΓΚΕΛΑ

**SUPERIOR 3D
LINE**

ΕΛΕΜ ΑΝΤΩΝΙΟΥ

ΚΟΥΦΩΜΑΤΑ ΑΛΟΥΜΙΝΙΟΥ-ΣΥΝΘΕΤΙΚΑ
ΠΑΡΑΔΟΣΙΑΚΑ ΚΑΓΚΕΛΑ



V10104



V10301



V10101

ΕΛ.ΕΜ. ΑΝΤΩΝΙΟΥ

ΚΟΥΦΩΜΑΤΑ ΑΛΟΥΜΙΝΙΟΥ-ΣΥΝΘΕΤΙΚΑ
ΓΑΡΑΔΟΣΙΑΚΑ ΚΑΓΚΕΛΑ



VERPAN | SUPERIOR 3D GIRAFFE LINE

ΕΛ.ΕΜ.ΑΝΤΩΝΙΟΥ

ΚΟΥΦΩΜΑΤΑ ΑΛΟΥΜΙΝΙΟΥ-ΣΥΝΘΕΤΙΚΑ
ΠΑΡΑΔΟΣΙΑΚΑ ΚΑΓΚΕΛΑ

SUPERIOR 3D GIRAFFELINE

An entrance that glows.

Inspired from nature!



ΕΛ.ΕΜ. ΑΝΤΩΝΙΟΥ
ΚΟΥΦΩΜΑΤΑ ΑΛΟΥΜΙΝΙΟΥ-ΣΥΝΘΕΤΙΚΑ
ΠΑΡΑΔΟΣΙΑΚΑ ΚΑΓΚΕΛΑ

**SUPERIOR 3D
GIRAFFELINE**

ΕΛ.ΕΜ. ΑΝΤΩΝΙΟΥ

ΚΟΥΦΩΜΑΤΑ ΑΛΟΥΜΙΝΙΟΥ-ΣΥΝΘΕΤΙΚΑ
ΠΑΡΑΔΟΣΙΑΚΑ ΚΑΓΚΕΛΑ

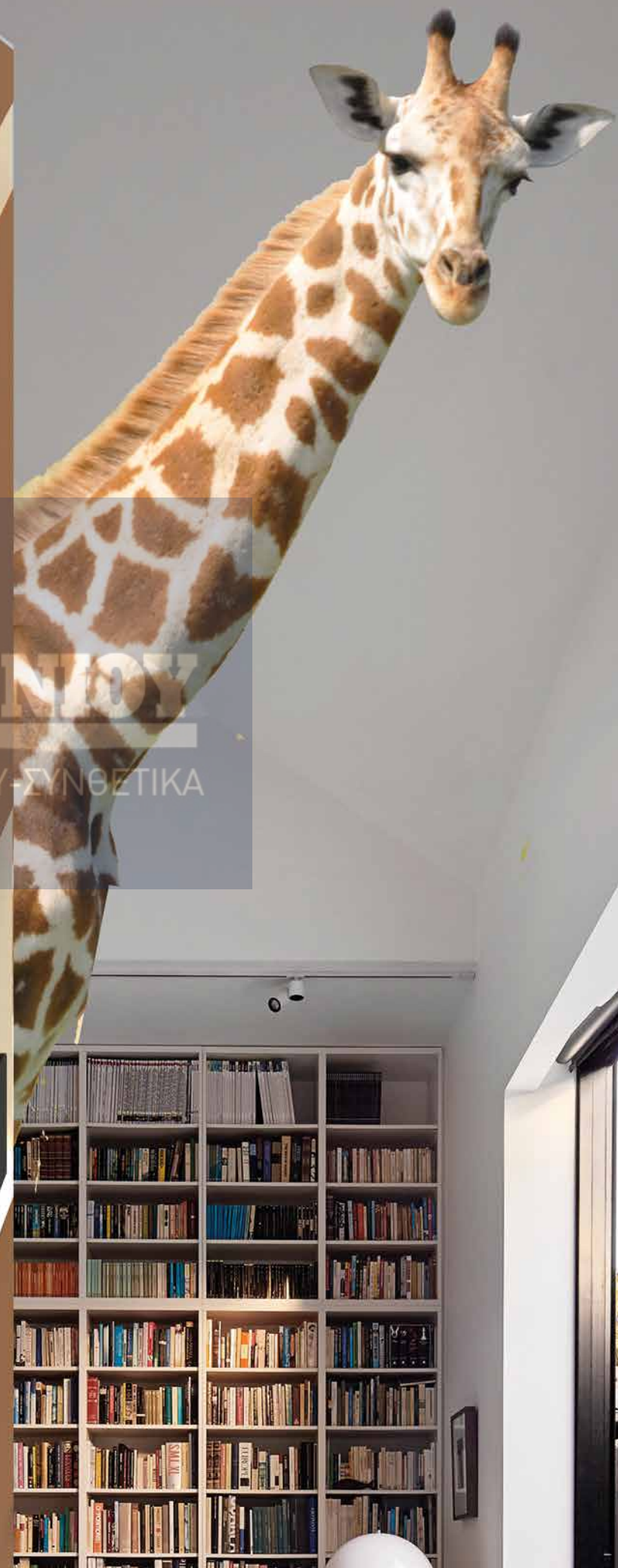



V20200



V20201

ΕΛΕΥΘΕΡΙΟΝ ΑΝΤΩΝΙΟΥ

ΚΟΥΦΩΜΑΤΑ ΑΛΟΥΜΙΝΙΟΥ-ΣΥΝΘΕΤΙΚΑ
ΠΑΡΑΔΟΣΙΑΚΑ ΚΑΓΚΕΛΑ

**SUPERIOR 3D
GIRAFFELINE**

ΕΛ.ΕΜ.ΑΝΤΩΝΙΟΥ

ΚΟΥΦΩΜΑΤΑ ΑΛΟΥΜΙΝΙΟΥ-ΣΥΝΘΕΤΙΚΑ
ΠΑΡΑΔΟΣΙΑΚΑ ΚΑΓΚΕΛΑ

V20202



V20203



V20204

ΕΛ.ΕΜ. ΑΝΤΩΝΙΟΥ

ΚΟΥΦΩΜΑΤΑ ΑΛΟΥΜΙΝΙΟΥ-ΣΥΝΘΕΤΙΚΑ
ΠΑΡΑΔΟΣΙΑΚΑ ΚΑΓΚΕΛΑ.

SUPERIOR 3D LINE

STANDARD EQUIPMENT

Both - sided sash overlapping panel 95.5mm. Aluminium thickness 3mm and 2x2mm. Inox ornaments on the same level with alu sheets.

- > **3 hinges** Rollenband 3D
- > **Inside handle** Inox ID-35
- > **Outside Handle Angular**
inox 1600mm placed on panel
- > **Glazing** 4 glasses, safety glass inside and outside 33.1+4+4+33.1
- > **Safety cylinder** with five keys
- > **Rosette ring**
- > **3 point** security door locking system with hooks
- > **Anodised Threshold**
- > **Ud = 0.81 W/m²K**

ΕΛ.ΕΜ. ΑΝΤΩΝΙΟΥ

ΚΟΥΦΩΜΑΤΑ ΑΛΟΥΜΙΝΙΟΥ - ΣΥΝΘΕΤΙΚΑ
ΠΑΡΑΔΟΣΙΑΚΑ ΚΑΓΚΕΛΑ

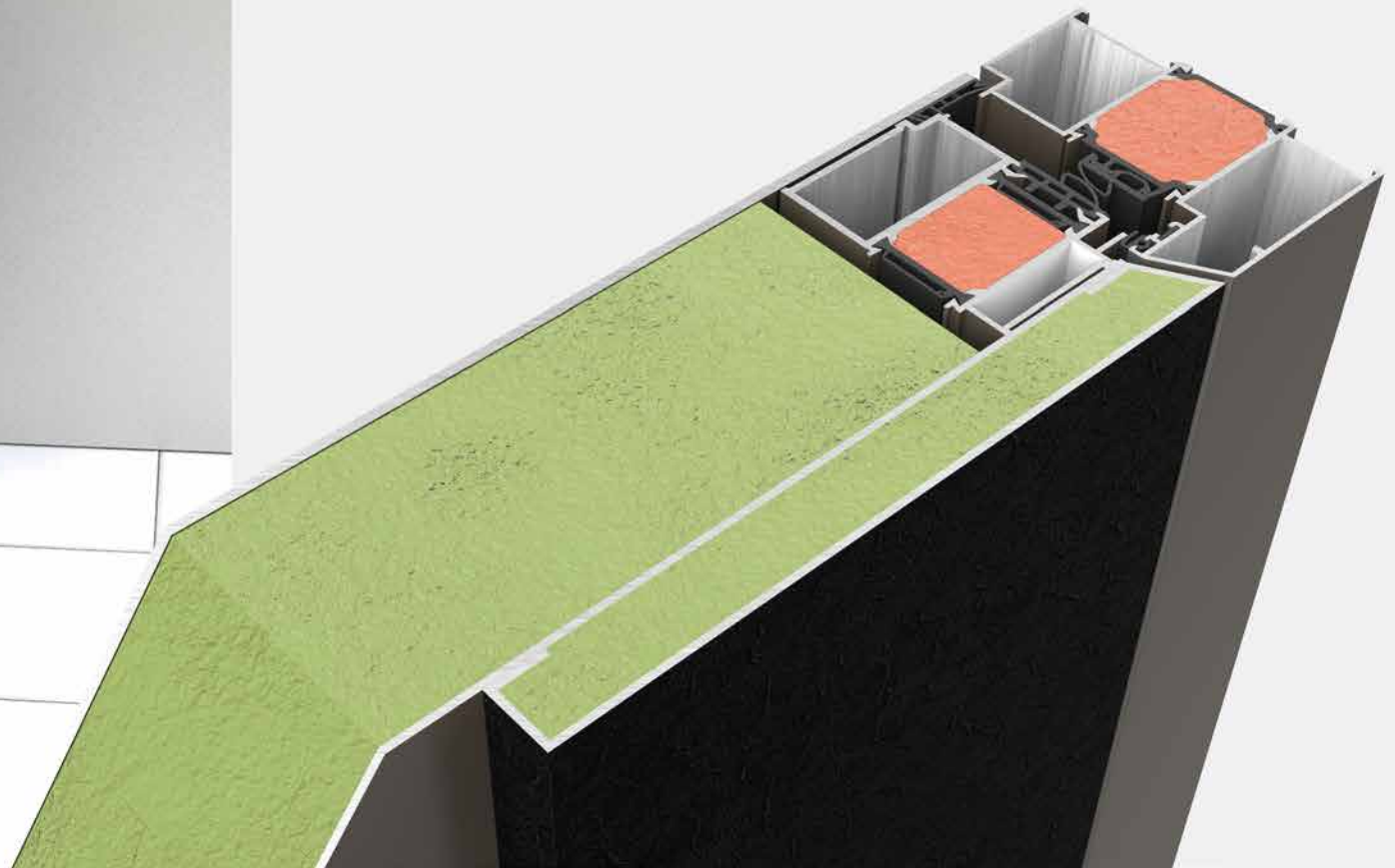

SUPERIOR 3D LINE

STANDARD EQUIPMENT



4 glasses, safety glass inside and outside 33.1+4+4+33.1



Safety cylinder EX-200



Round rosette EX-900



Rollenband EX-304



Inside Handle ID-35 EX-502



OUTSIDE HANDLE 1600MM
V440.60.1600

3 point hooklock



EX-100

VERTICAL SECTION

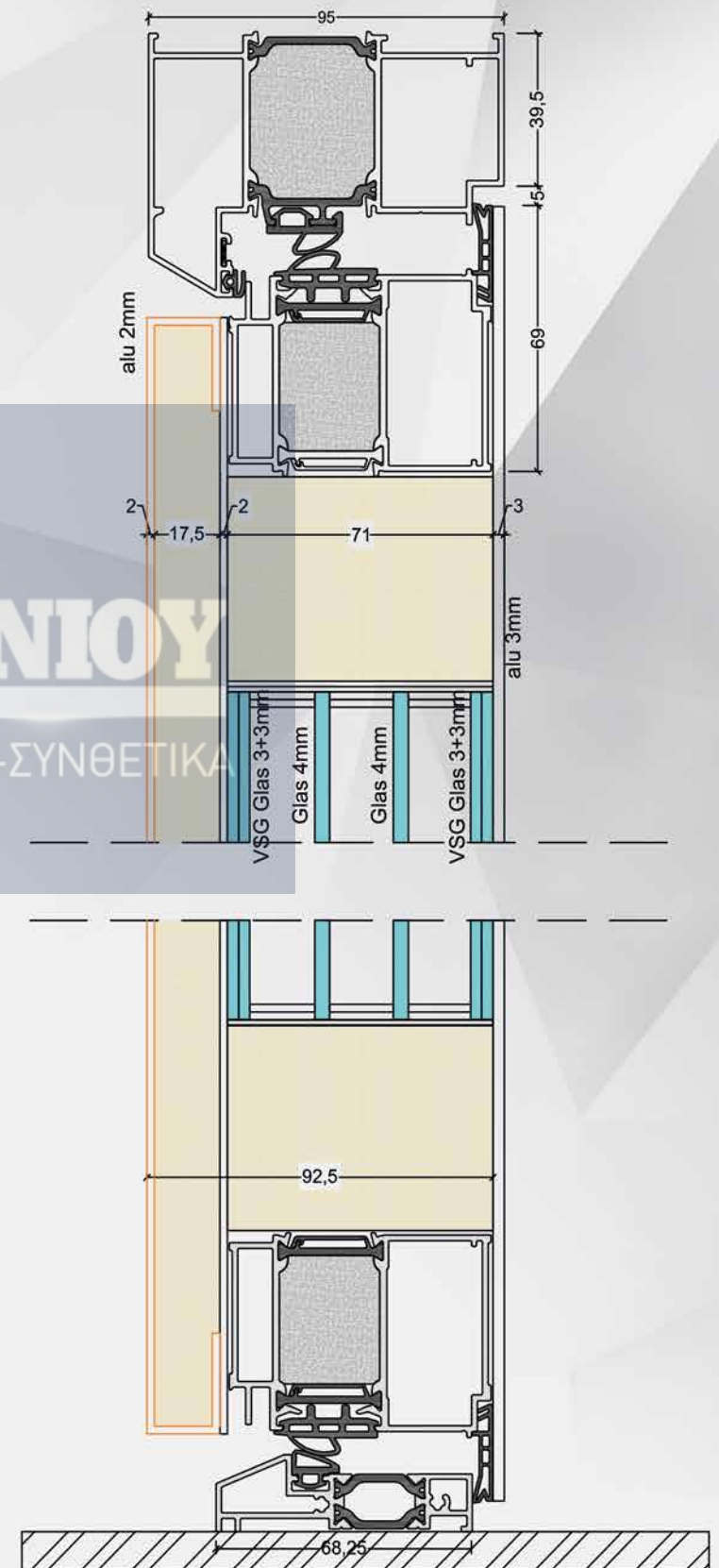

ΕΛ.ΕΜ.ΑΝΤΩΝΙΟΥ

ΚΟΥΦΩΜΑΤΑ ΑΛΟΥΜΙΝΙΟΥ-ΣΥΝΘΕΤΙΚΑ
ΠΑΡΑΔΟΣΙΑΚΑ ΚΑΤΕΛΑ

AVANTAGELINE

ELMANTONIOU 069-0322018



ΕΛ.ΕΜ. ΑΝΤΩΝΙΟΥ
ΚΟΥΦΩΜΑΤΑ ΑΛΟΥΜΙΝΙΟΥ-ΣΥΝΘΕΤΙΚΑ
ΠΑΡΑΔΟΣΙΑΚΑ ΚΑΓΚΕΛΑ

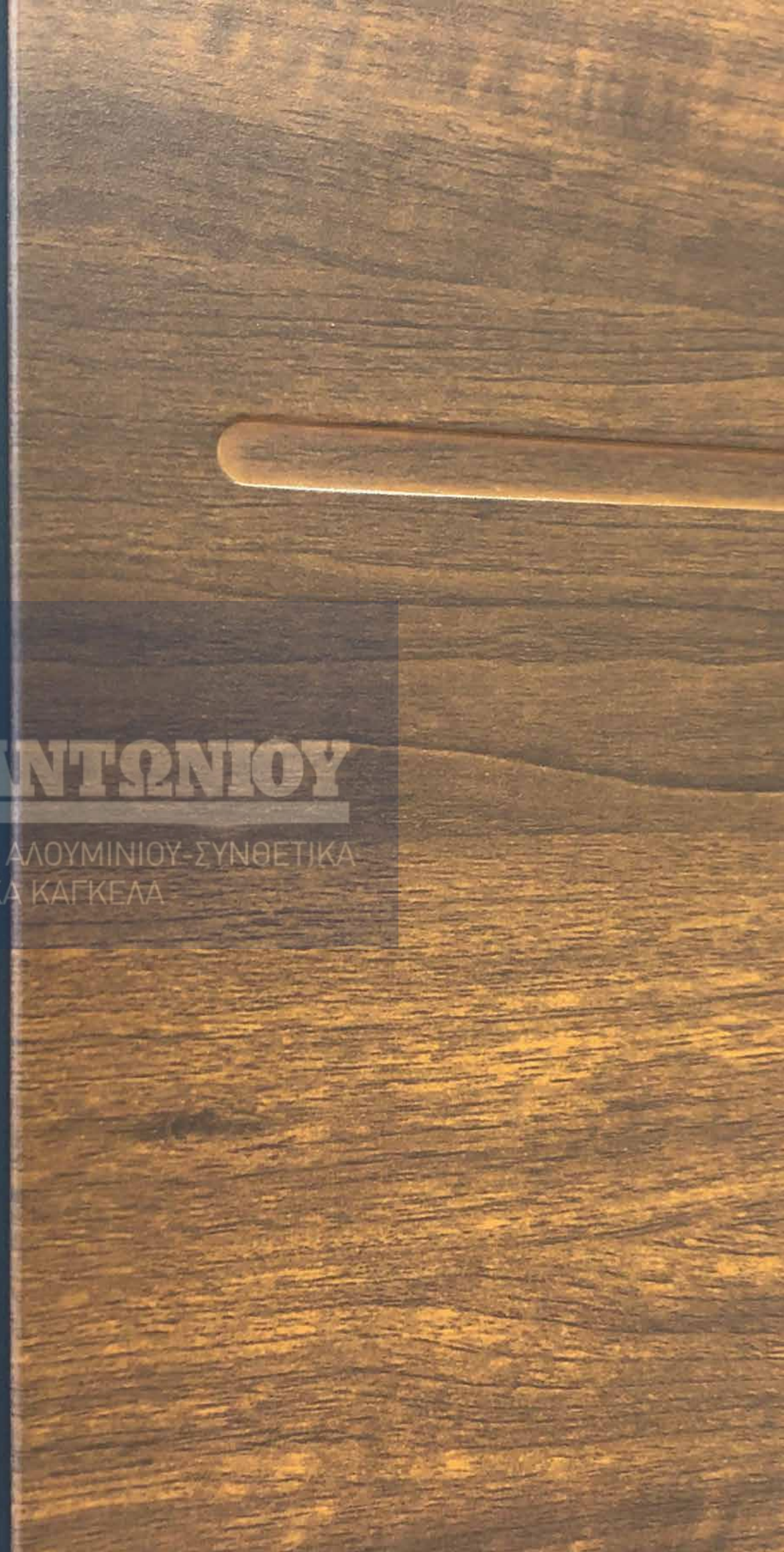

AVANTAGELINE

The absolute flat!
Touch and feel a refined, flat, glassy surface.



Install an Entrance door from Avantage line.
Let people wonder what is behind!!!

AVANTAGE
LINE

ΕΛ.ΕΜ. ΑΝΤΩΝΙΟΥ
ΚΟΥΦΩΜΑΤΑ ΑΛΟΥΜΙΝΙΟΥ-ΣΥΝΘΕΤΙΚΑ
ΠΑΡΑΔΟΣΙΑΚΑ ΚΑΤΕΥΛΑ

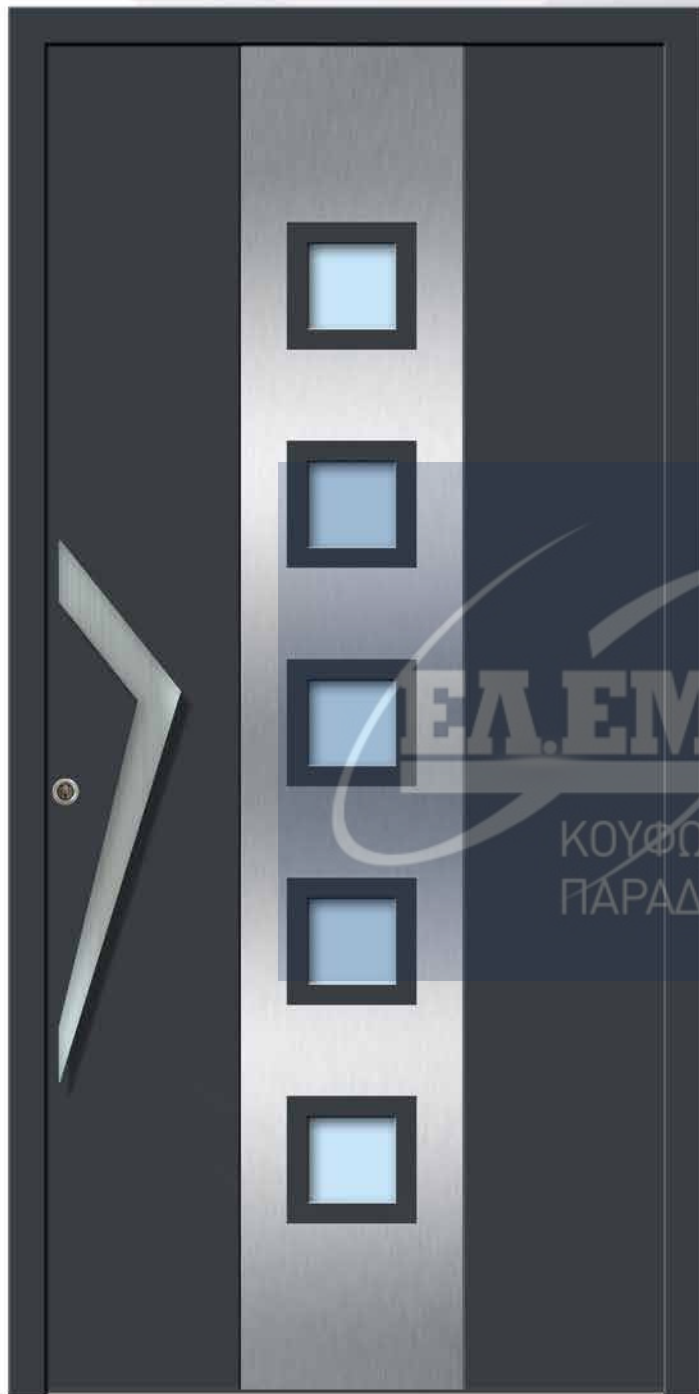

VO143
AVANTAGE | ELEGRAND LINE



VO170
AVANTAGE | ELEGRAND LINE

ΕΛ.ΕΜ.ΑΝΤΩΝΙΟΥ
ΚΟΥΦΩΜΑΤΑ ΑΛΟΥΜΙΝΙΟΥ-ΣΥΝΘΕΤΙΚΑ
ΠΑΡΑΔΟΣΙΑΚΑ ΚΑΓΚΕΛΑ

AVANTAGE LINE

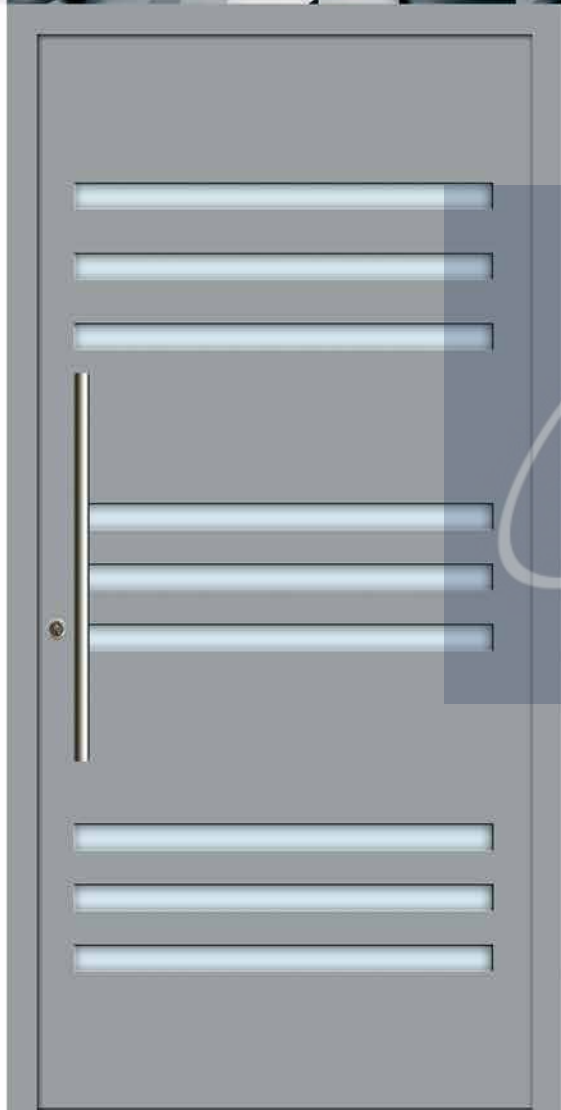

Vo480
AVANTAGE LINE



Vo220
AVANTAGE LINE



Vo232
AVANTAGE | ELEGRAND LINE

ΕΛΕΜ ΑΝΤΩΝΙΟΥ
ΚΟΥΦΩΜΑΤΑ ΑΛΟΥΜΙΝΙΟΥ-ΣΥΝΘΕΤΙΚΑ
ΠΑΡΑΔΟΣΙΑΚΑ ΚΑΓΚΕΛΑ



ΕΛ.ΕΜ. ΑΝΤΩΝΙΟΥ
ΚΟΥΦΩΜΑΤΑ ΑΛΟΥΜΙΝΙΟΥ-ΣΥΝΘΕΤΙΚΑ
ΠΑΡΑΔΟΣΙΑΚΑ ΚΑΓΚΕΛΑ

VO321

AVANTAGE | ELEGRAND LINE

**AVANTAGE
LINE**

ΕΛ.ΕΜ. ΑΝΤΩΝΙΟΥ

ΚΟΥΦΩΜΑΤΑ ΑΛΟΥΜΙΝΙΟΥ-ΣΥΝΘΕΤΙΚΑ
ΠΑΡΑΔΟΣΙΑΚΑ ΚΑΓΚΕΛΑ



VO340

AVANTAGE | ELEGRAND LINE



VO430
AVANTAGE LINE



VO453
AVANTAGE | ELEGRAND LINE

ΕΛ.ΕΜ. ΑΝΤΩΝΙΟΥ

ΚΟΥΦΩΜΑΤΑ ΑΛΟΥΜΙΝΙΟΥ-ΣΥΝΘΕΤΙΚΑ
ΠΑΡΑΔΟΣΙΑΚΑ ΚΑΓΚΕΛΑ

AVANTAGE LINE

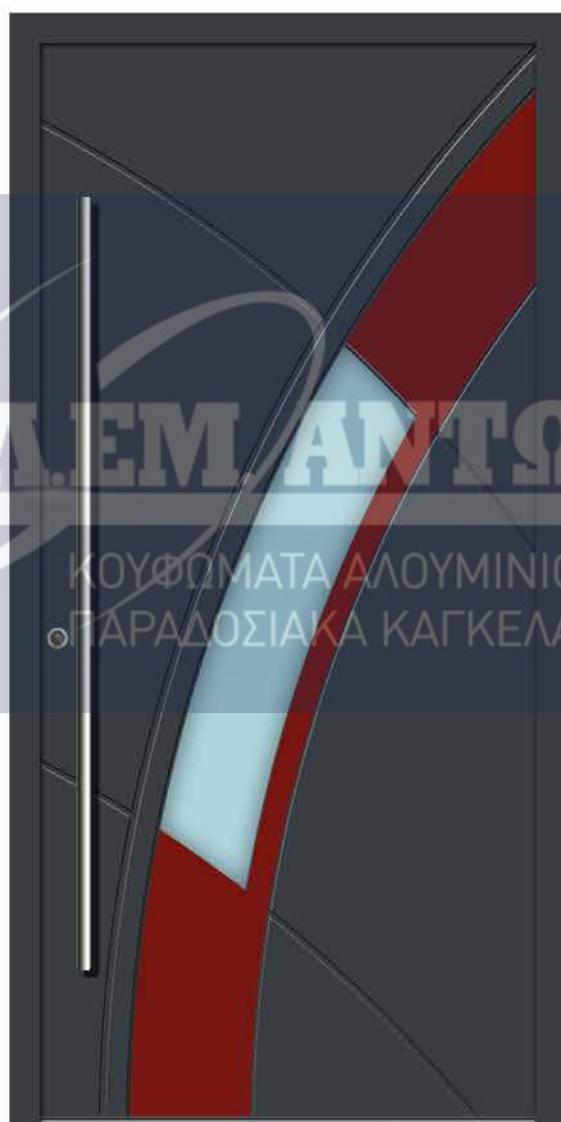
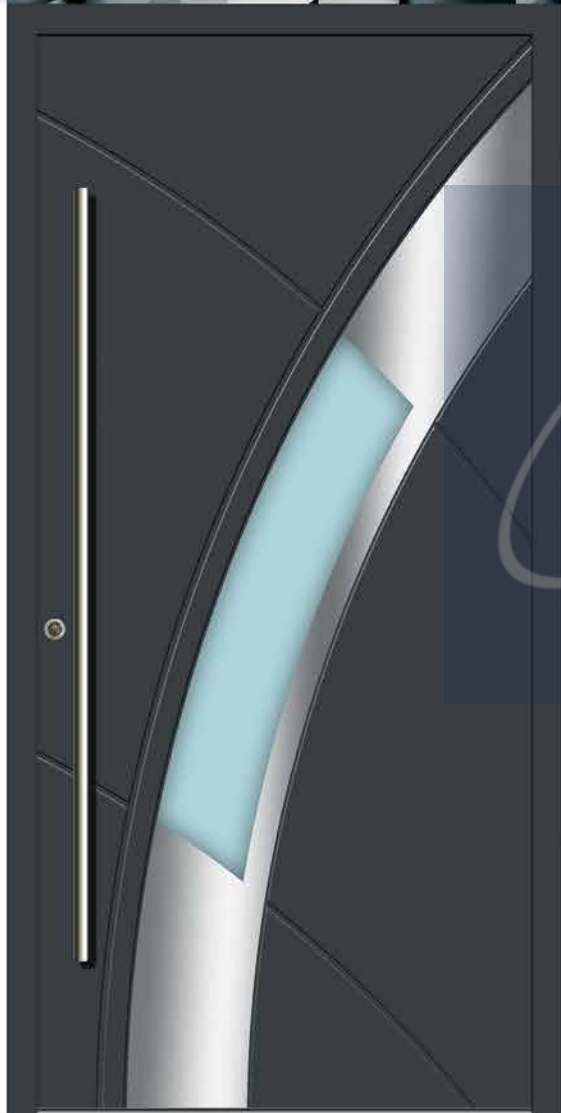

VO462

AVANTAGE | ELEGRAND LINE

VO463

AVANTAGE | ELEGRAND LINE

VO470

AVANTAGE | ELEGRAND LINE

ΕΛ.ΕΜ. ΑΝΤΩΝΙΟΥ
ΚΟΥΦΩΜΑΤΑ ΑΛΟΥΜΙΝΙΟΥ-ΣΥΝΘΕΤΙΚΑ
ΠΑΡΑΔΟΣΙΑΚΑ ΚΑΓΚΕΛΑ



ΕΛ.ΕΜ.ΑΝΤΩΝΙΟΥ
ΚΟΥΦΩΜΑΤΑ ΑΛΟΥΜΙΝΙΟΥ-ΣΥΝΘΕΤΙΚΑ
ΠΑΡΑΔΟΣΙΑΚΑ ΚΑΓΚΕΛΑ

VO103
AVANTAGE | ELEGRAND LINE

AVANTAGE LINE

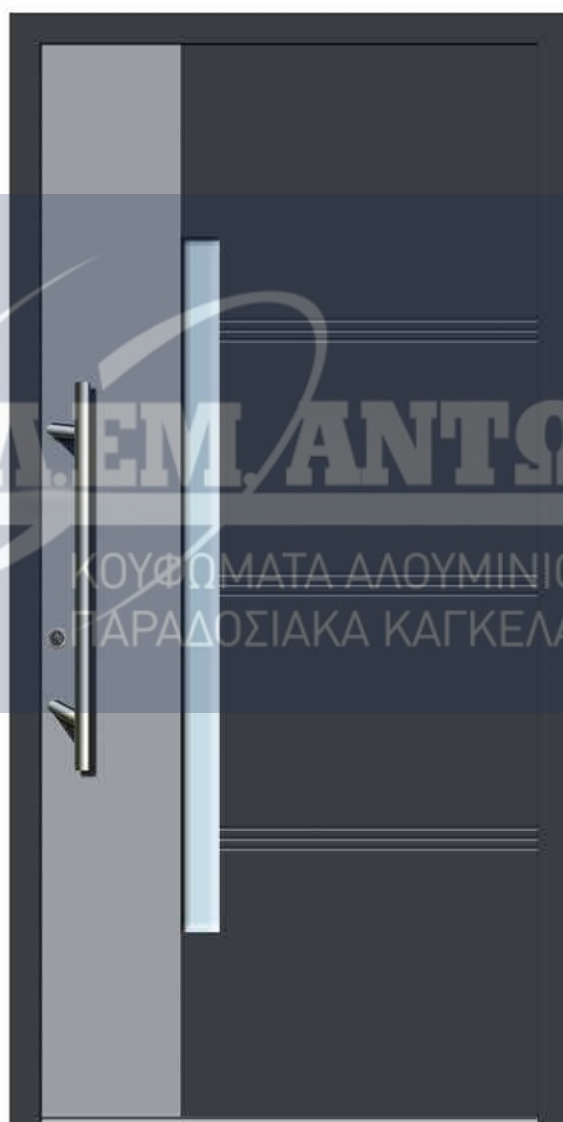

V0500
AVANTAGE | ELEGRAND LINE

V0502
AVANTAGE | ELEGRAND LINE

V0560
AVANTAGE | ELEGRAND LINE

ΕΛΕΜ. ΑΝΤΩΝΙΟΥ
ΚΟΥΦΩΜΑΤΑ ΑΛΟΥΜΙΝΙΟΥ-ΣΥΝΘΕΤΙΚΑ
ΠΑΡΑΔΟΣΙΑΚΑ ΚΑΓΚΕΛΑ



V1330

AVANTAGE | ELEGRAND LINE



V1350

AVANTAGE | ELEGRAND LINE

ΕΛ.ΕΜ. ΑΝΤΩΝΙΟΥ
ΚΟΥΦΩΜΑΤΑ ΑΛΟΥΜΙΝΙΟΥ-ΣΥΝΘΕΤΙΚΑ
ΠΑΡΑΔΟΣΙΑΚΑ ΚΑΓΚΕΛΑ

AVANTAGE LINE



V1360
AVANTAGE | ELEGRAND LINE

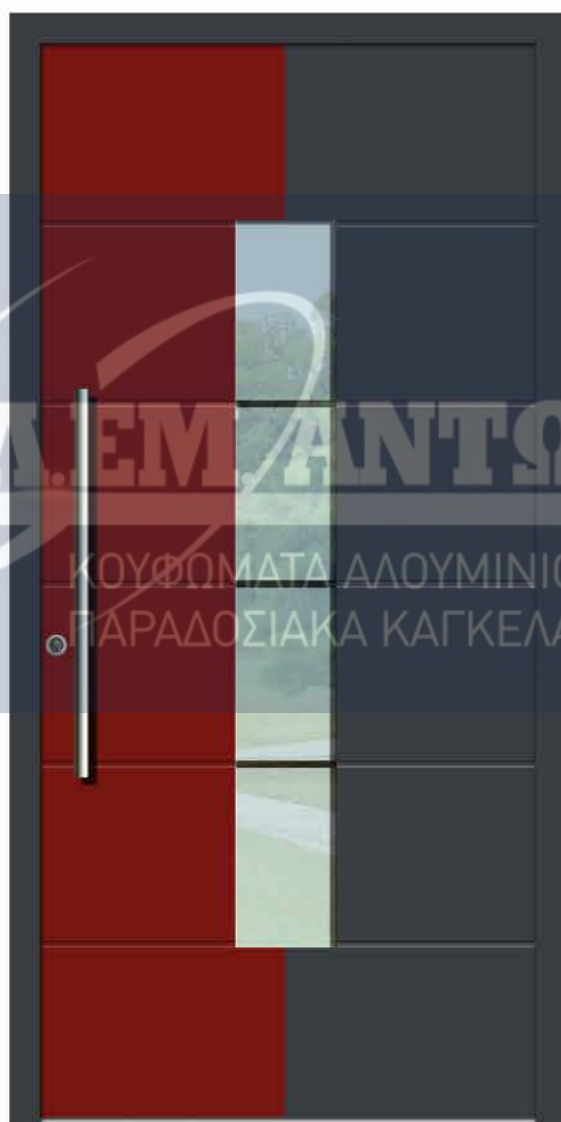

V1390
AVANTAGE | ELEGRAND LINE

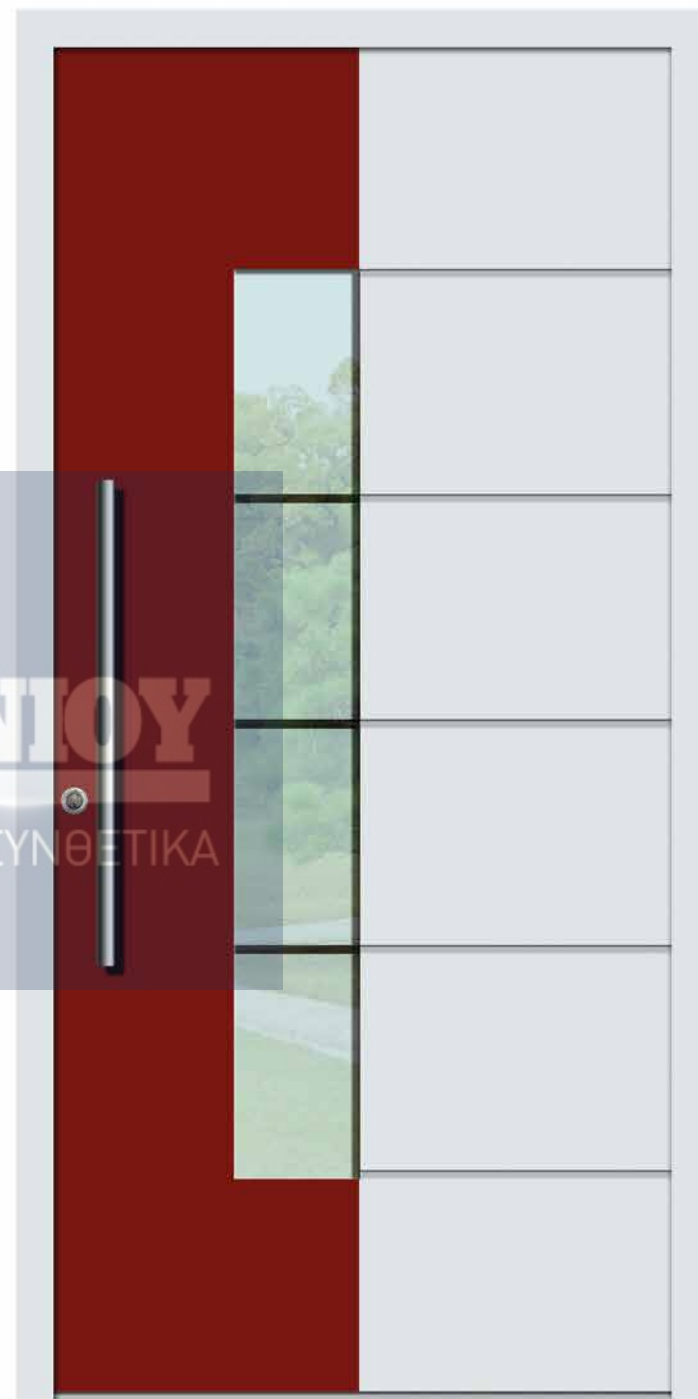

V1400
AVANTAGE | ELEGRAND LINE

ΕΛΕΜ ΑΝΤΩΝΙΟΥ
ΚΟΥΦΟΜΑΤΑ ΑΛΟΥΜΙΝΙΟΥ-ΣΥΝΘΕΤΙΚΑ
ΠΑΡΑΔΟΣΙΑΚΑ ΚΑΓΚΕΛΑ



ΕΛ.ΕΜ. ΑΝΤΩΝΙΟΥ
ΚΟΥΦΩΜΑΤΑ ΑΛΟΥΜΙΝΙΟΥ ΣΥΝΘΕΤΙΚΑ
ΠΑΡΑΔΟΣΙΑΚΑ ΚΑΓΚΕΛΑ

V1410
AVANTAGE | ELEGRAND LINE

**AVANTAGE
LINE**

ΕΛ.ΕΜ. ΑΝΤΩΝΙΟΥ

ΚΟΥΦΩΜΑΤΑ ΑΛΟΥΜΙΝΙΟΥ-ΣΥΝΘΕΤΙΚΑ
ΠΑΡΑΔΟΣΙΑΚΑ ΚΑΓΚΕΛΑ



V1220

AVANTAGE | ELEGRAND LINE



V1230
AVANTAGE | ELEGRAND LINE



V1300
AVANTAGE | ELEGRAND LINE

ΕΛ ΕΜ. ΑΝΤΩΝΙΟΥ

ΚΟΥΦΩΜΑΤΑ ΑΛΟΥΜΙΝΙΟΥ-ΣΥΝΘΕΤΙΚΑ
ΠΑΡΑΔΟΣΙΑΚΑ ΚΑΓΚΕΛΑ

AVANTAGE LINE

STANDARD EQUIPMENT

Both - sided sash overlapping panel 77mm. Aluminium thickness 3mm and 3mm. Inox ornaments on the same level with alu sheets.

- > **3 hinges** 3D
- > **Inside handle** Inox ID-20
- > **Outside Handle Round**
inox 800 mm placed on sash
- > **Glazing** 4 glasses, safety glass
outside 33.1+4+4+4
- > **Safety cylinder** with five keys
- > **Rosette ring**
- > **3 point** security door locking
system with hooks
- > **Anodised Threshold**
- > **Ud = 0.92 W/m²K**

ΕΛ.ΕΜ. ΑΝΤΩΝΙΟΥ

ΚΟΥΦΩΜΑΤΑ ΑΛΟΥΜΙΝΙΟΥ-ΣΥΝΘΕΤΙΚΑ
ΠΑΡΑΔΟΣΙΑΚΑ ΚΑΓΚΕΛΑ

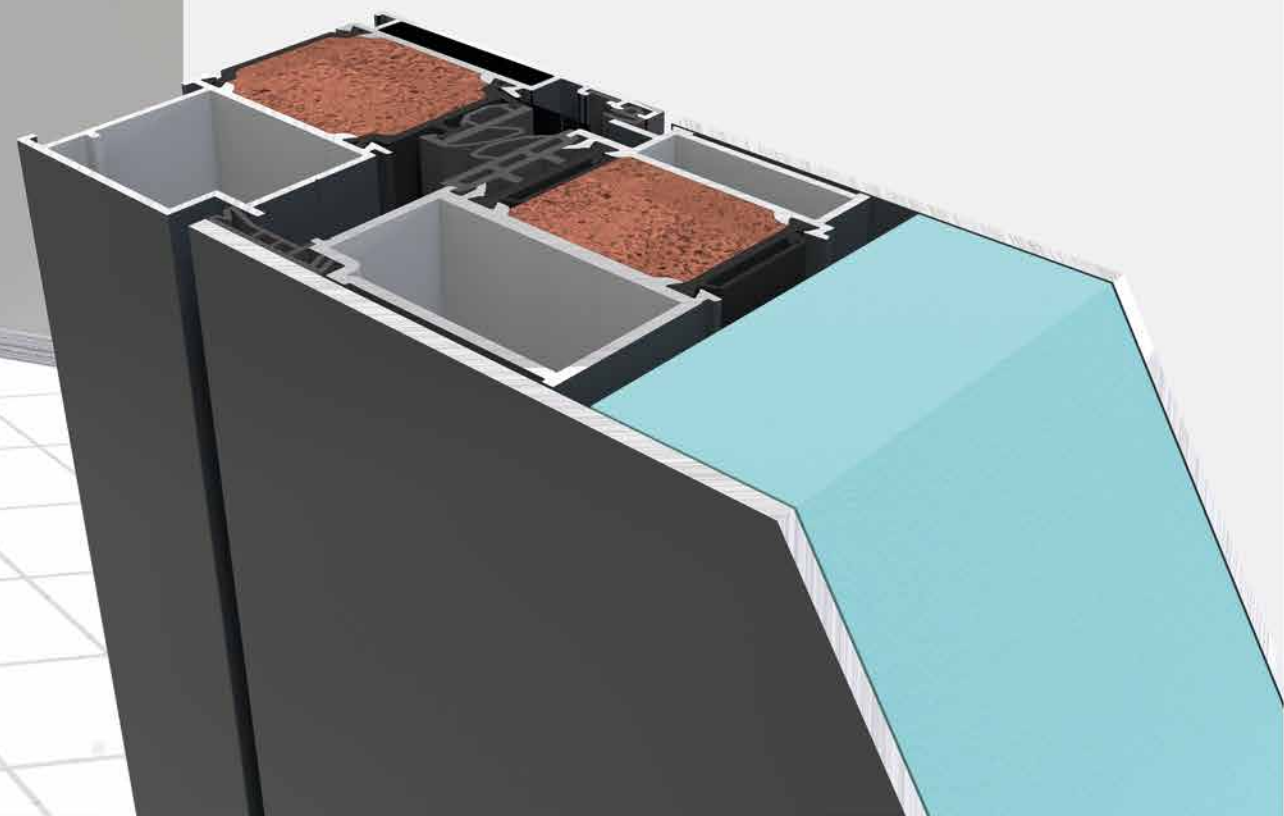

AVANTAGE LINE

STANDARD EQUIPMENT



4 glasses, safety glass
outside 33.1+4+4+4



Safety cylinder
EX-200



Round rosette
EX-900

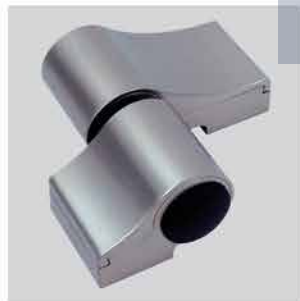

3D Hinge
EX-301



Inside Handle ID-20
EX-500



OUTSIDE HANDLE 800MM
V175.30.800



3 point hooklock
EX-100

VERTICAL SECTION

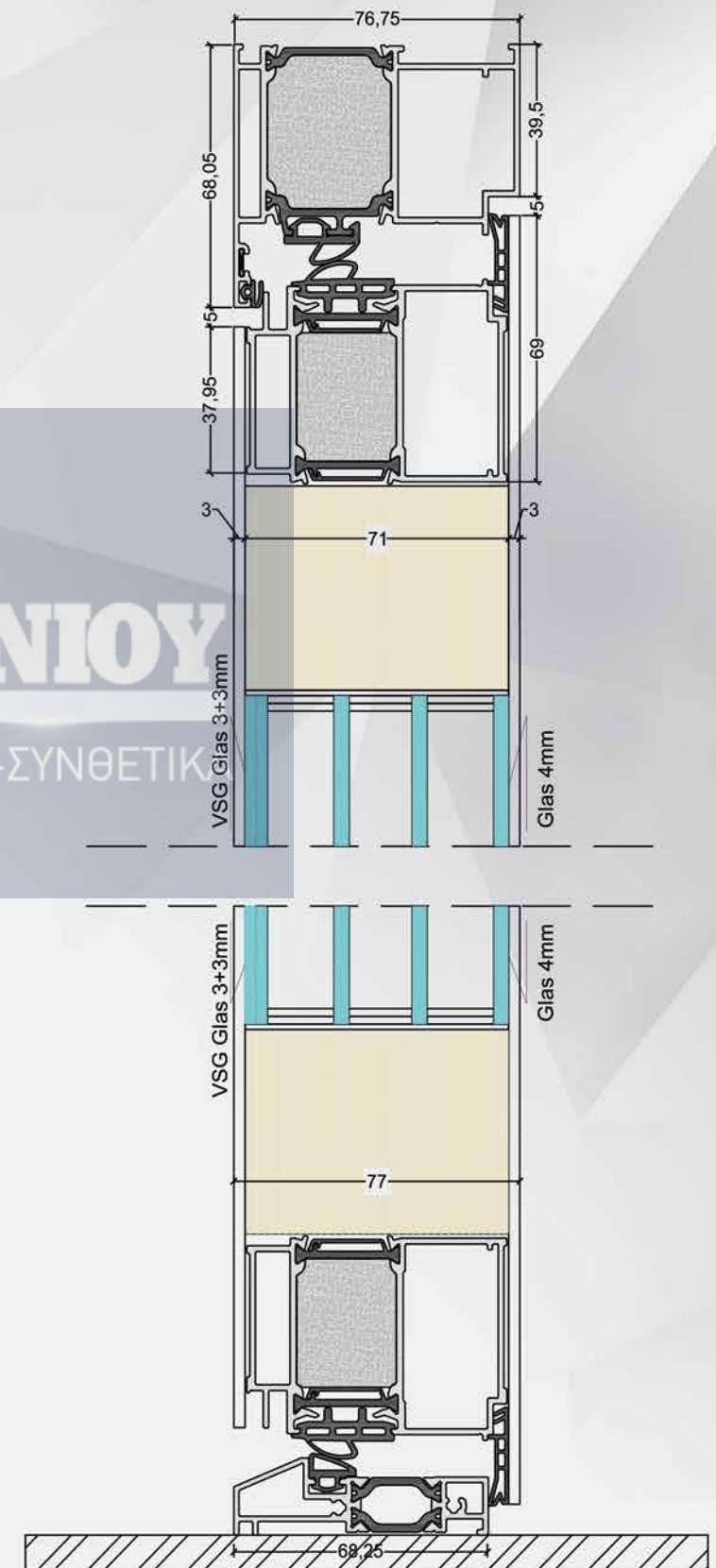

ΕΛΕΜ ΑΝΩΝΥΜΟΝ

ΚΟΥΦΩΜΑΤΑ ΑΛΟΥΜΙΝΙΟΥ-ΣΥΝΘΕΤΙΚΑ
ΠΑΡΑΔΟΣΙΑΚΑ ΚΑΤΚΕΛΑ

ELEGRANDLINE

ΕΛ.ΕΜ.ΑΝΤΩΝΙΟΥ

ΚΟΥΦΩΜΑΤΑ ΑΛΟΥΜΙΝΙΟΥ-ΣΥΝΘΕΤΙΚΑ
ΠΑΡΑΔΟΣΙΑΚΑ ΚΑΓΚΕΛΑ

ELEGRANDLINE

As flat as curved!



ΕΛ.ΕΜ. ΑΝΤΩΝΙΟΥ
ΚΟΥΦΩΜΑΤΑ ΑΛΟΥΜΙΝΙΟΥ-ΣΥΝΘΕΤΙΚΑ
ΠΑΡΑΔΟΣΙΑΚΑ ΚΑΓΚΕΛΑ

When architecture demands it!!!

ELEGRAND
LINE

ΕΛ.ΕΜ. ΑΝΤΩΝΙΟΥ

ΚΟΥΦΩΜΑΤΑ ΑΛΟΥΜΙΝΙΟΥ-ΣΥΝΘΕΤΙΚΑ
ΠΑΡΑΔΟΣΙΑΚΑ ΚΑΓΚΕΛΑ





Vo101

ELEGRAND | AVANTAGE LINE



Vo102

ELEGRAND | AVANTAGE LINE

ΕΛ.ΕΜ. ΑΝΤΩΝΙΟΥ
ΚΟΥΦΩΜΑΤΑ ΑΛΟΥΜΙΝΙΟΥ-ΣΥΝΘΕΤΙΚΑ
ΠΑΡΑΔΟΣΙΑΚΑ ΚΑΓΚΕΛΑ

ELEGRAND LINE



Vo130

ELEGRAND | AVANTAGE
COMPACT | ECO LINE



Vo151

ELEGRAND | AVANTAGE LINE

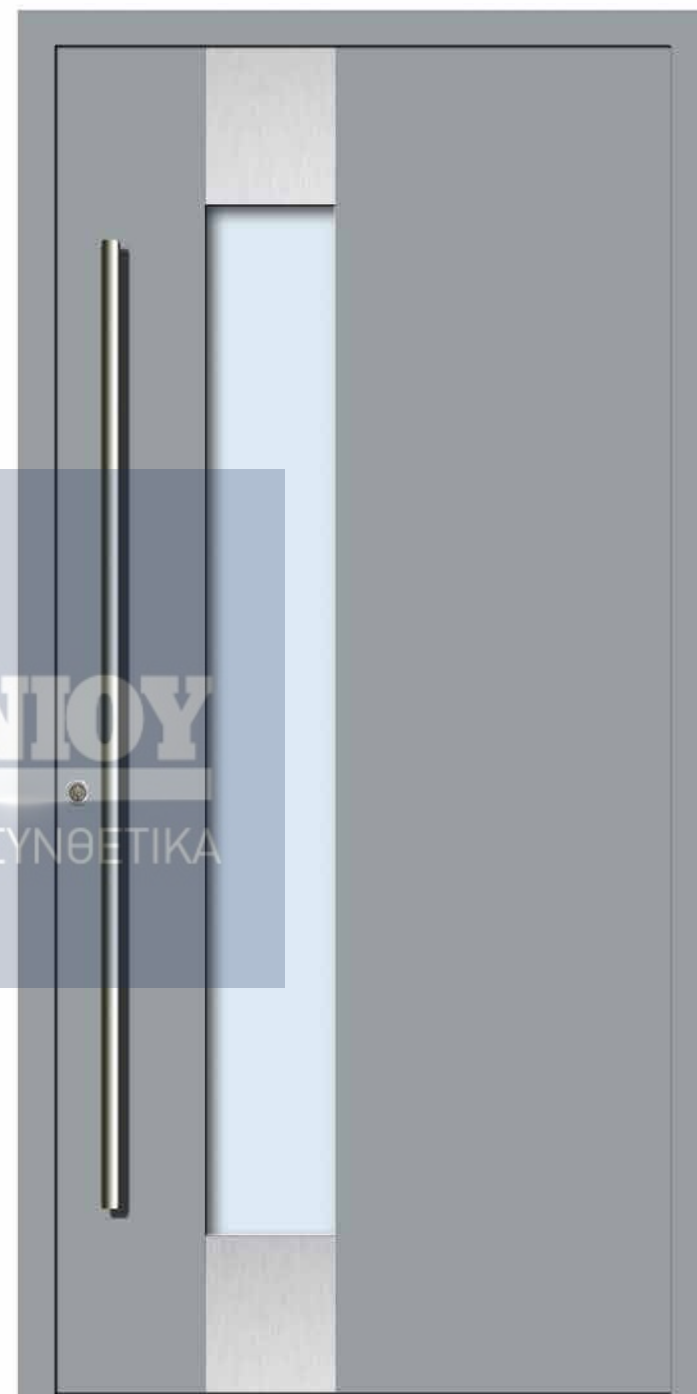

Vo171

ELEGRAND | AVANTAGE LINE

ΕΛ.ΕΜ. ΑΝΤΩΝΙΟΥ

ΚΟΥΦΩΜΑΤΑ ΑΛΟΥΜΙΝΙΟΥ-ΣΥΝΘΕΤΙΚΑ
ΠΑΡΑΔΟΣΙΑΚΑ ΚΑΓΚΕΛΑ

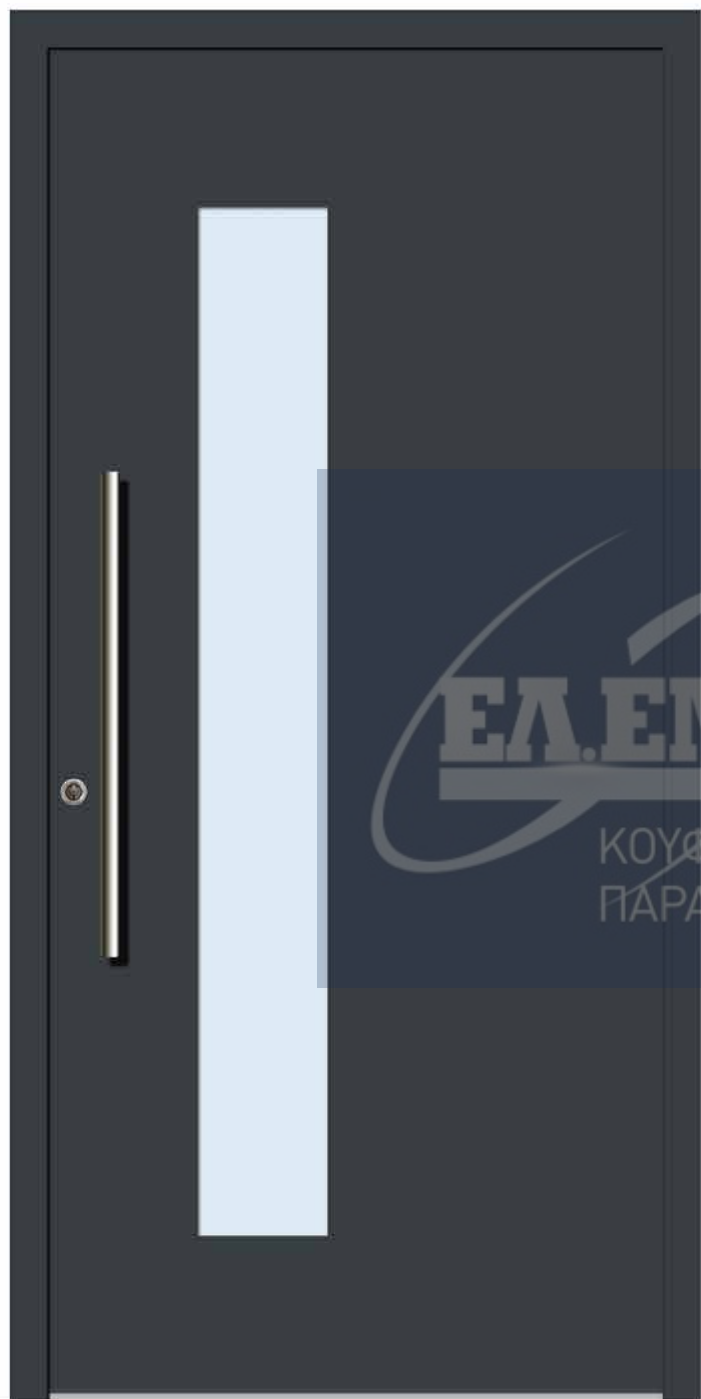

VO172

ELEGRAND | AVANTAGE LINE

ΕΛ.ΕΜ.ΑΝΤΩΝΙΟΥ
ΚΟΥΦΩΜΑΤΑ ΑΛΟΥΜΙΝΙΟΥ-ΣΥΝΘΕΤΙΚΑ
ΠΑΡΑΔΟΣΙΑΚΑ ΚΑΤΕΛΑ

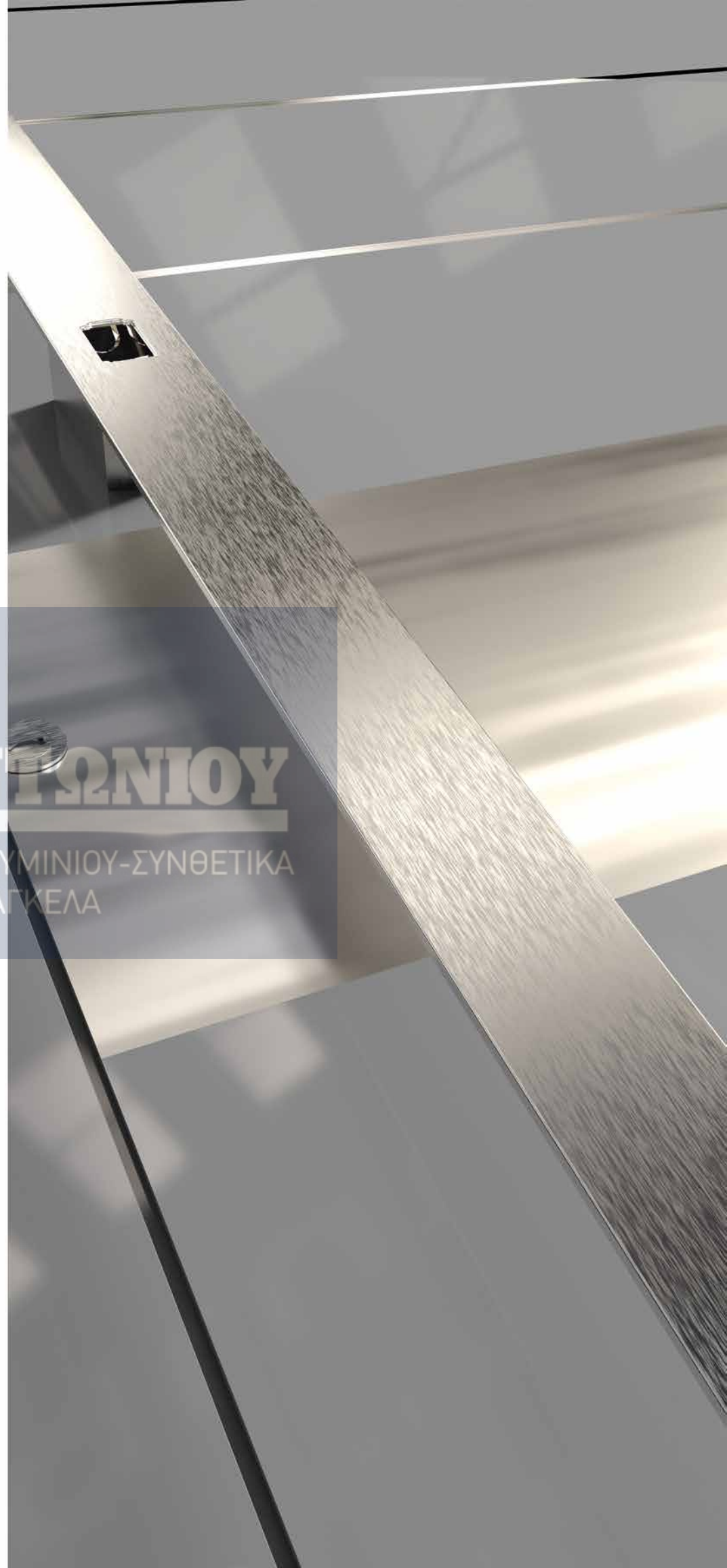

ELEGRAND
LINE

ΕΛ.ΕΜ. ΑΝΤΩΝΙΟΥ

ΚΟΥΦΩΜΑΤΑ ΑΛΟΥΜΙΝΙΟΥ-ΣΥΝΘΕΤΙΚΑ
ΠΑΡΑΔΟΣΙΑΚΑ ΚΑΓΚΕΛΑ



V1630

ELEGRAND | AVANTAGE
COMPACT | ECO LINE

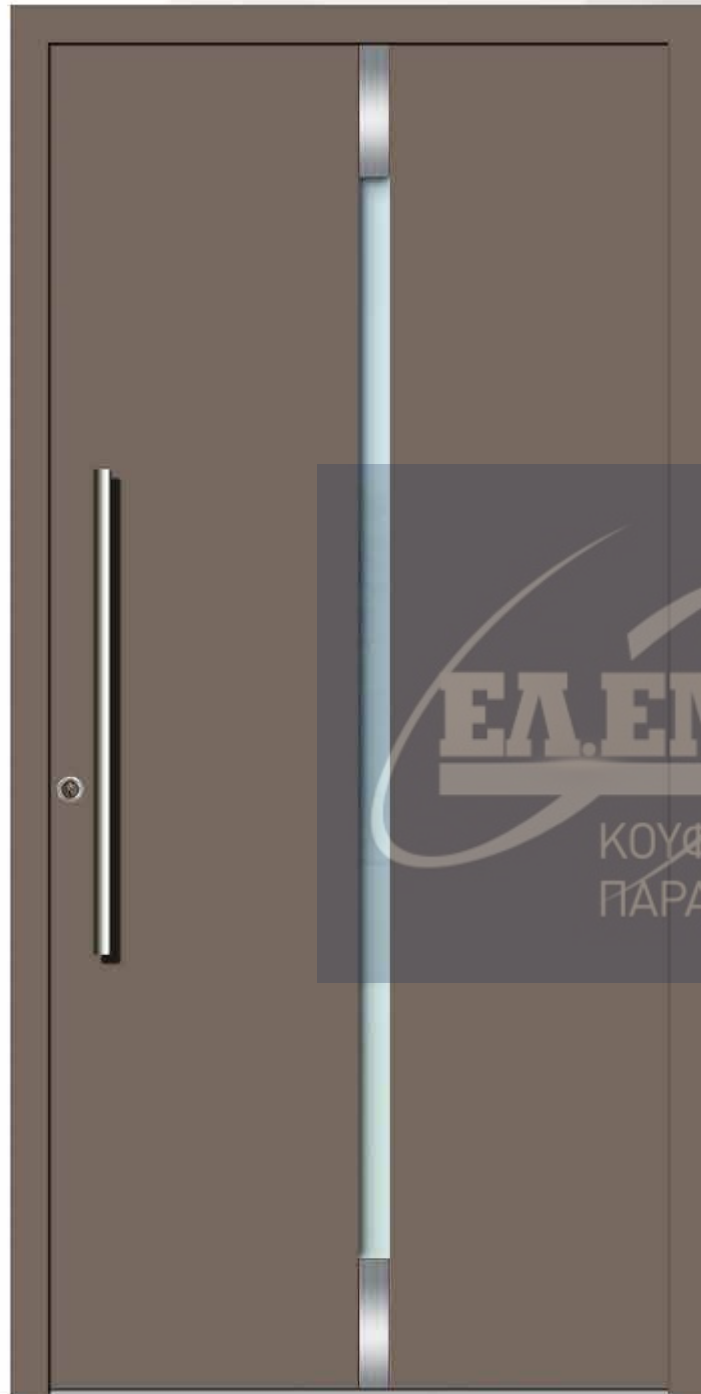

VO210
ELEGRAND | AVANTAGE | COMPACT LINE



VO221
ELEGRAND | AVANTAGE LINE

ΕΛ.ΕΜ. ΑΝΤΩΝΙΟΥ

ΚΟΥΦΩΜΑΤΑ ΑΛΟΥΜΙΝΙΟΥ-ΣΥΝΘΕΤΙΚΑ
ΠΑΡΑΔΟΣΙΑΚΑ ΚΑΓΚΕΛΑ

ELEGRAND
LINE

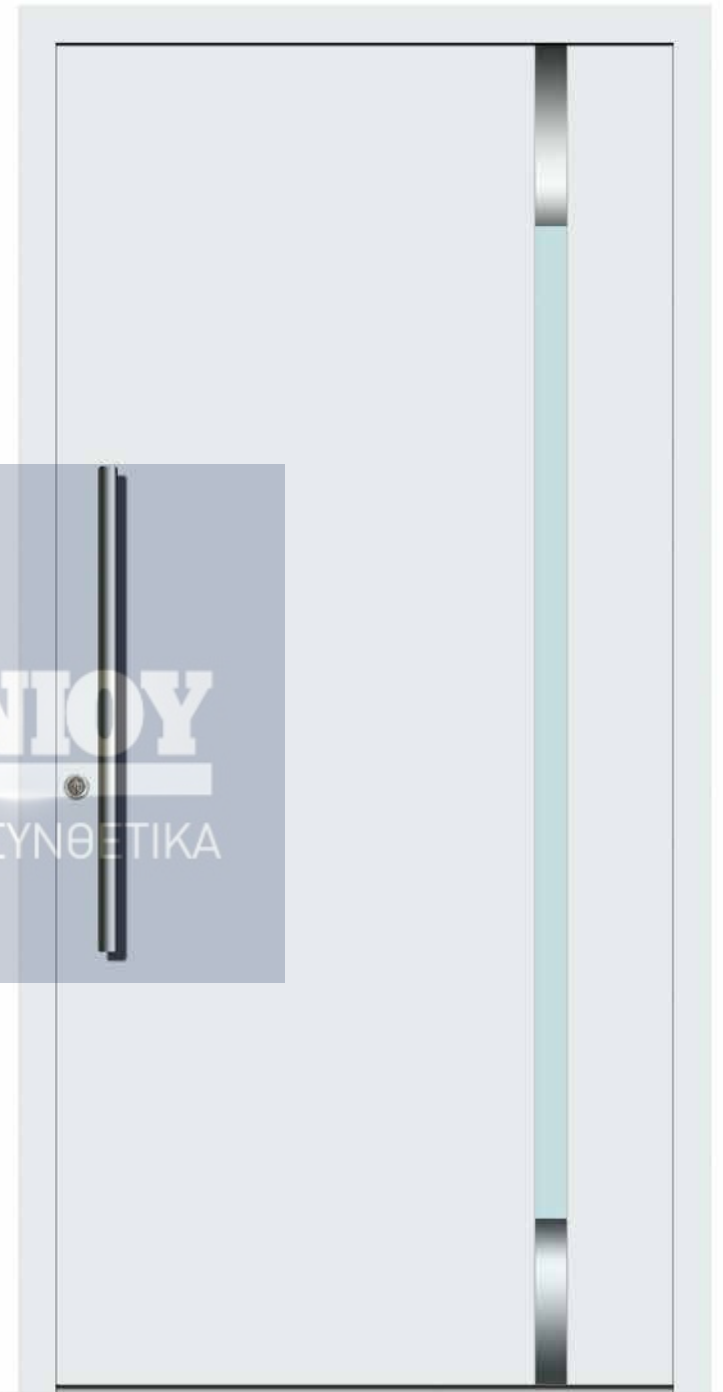

Vo230
ELEGRAND | AVANTAGE LINE

Vo250
ELEGRAND | AVANTAGE LINE

Vo251
ELEGRAND | AVANTAGE LINE



ΕΛ.ΕΜ. ΑΝΤΩΝΟΥ
ΚΟΥΦΩΜΑΤΑ ΑΛΟΥΜΙΝΙΟΥ ΚΑΙ ΞΥΛΙΝΑ
ΠΑΡΑΔΟΣΙΑΚΑ ΚΑΓΚΕΛΑ

Vo260
ELEGRAND | AVANTAGE LINE

ELEGRAND
LINE



Vo281
ELEGRAND | AVANTAGE LINE



Vo302
ELEGRAND | AVANTAGE LINE

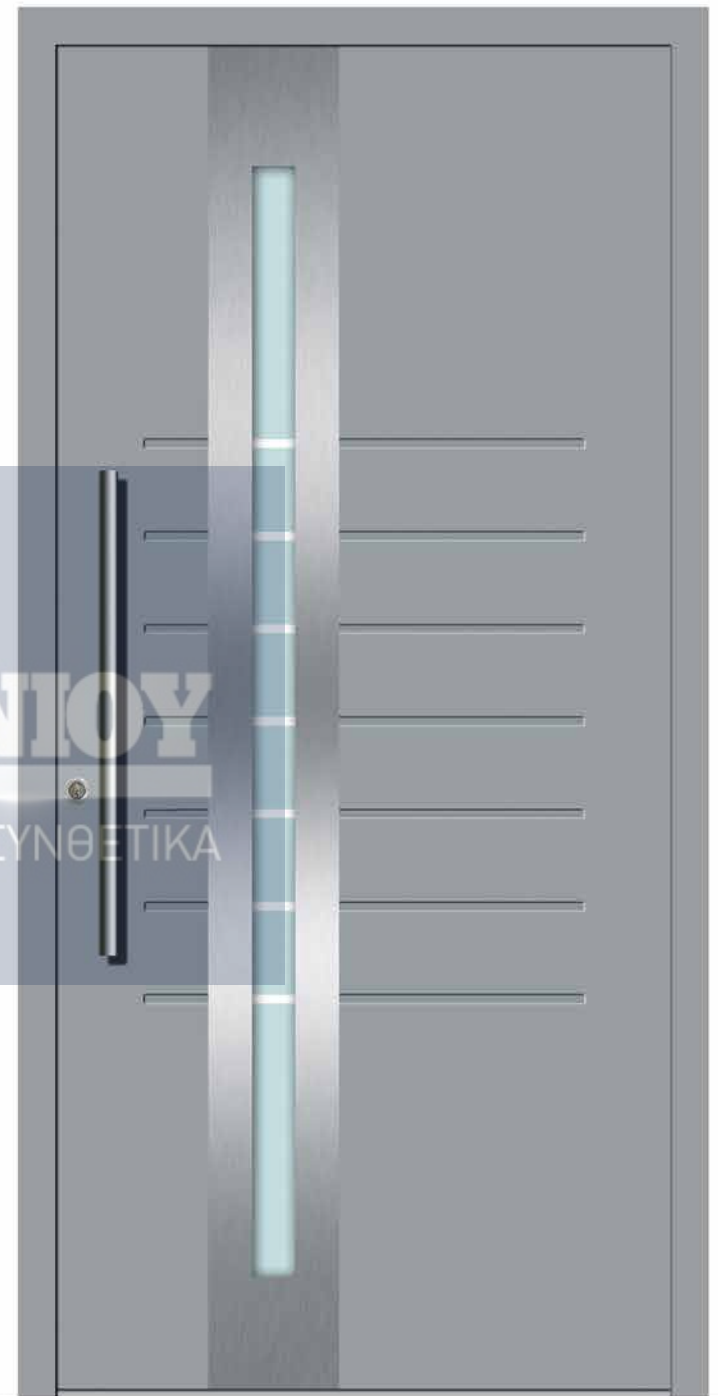

Vo320
ELEGRAND | AVANTAGE LINE

ΕΛ.ΕΜ. ΑΝΤΩΝΙΟΥ
ΚΟΥΦΩΜΑΤΑ ΑΛΟΥΜΙΝΙΟΥ-ΣΥΝΘΕΤΙΚΑ
ΠΑΡΑΔΟΣΙΑΚΑ ΚΑΓΚΕΛΑ



VO330
ELEGRAND | AVANTAGE LINE

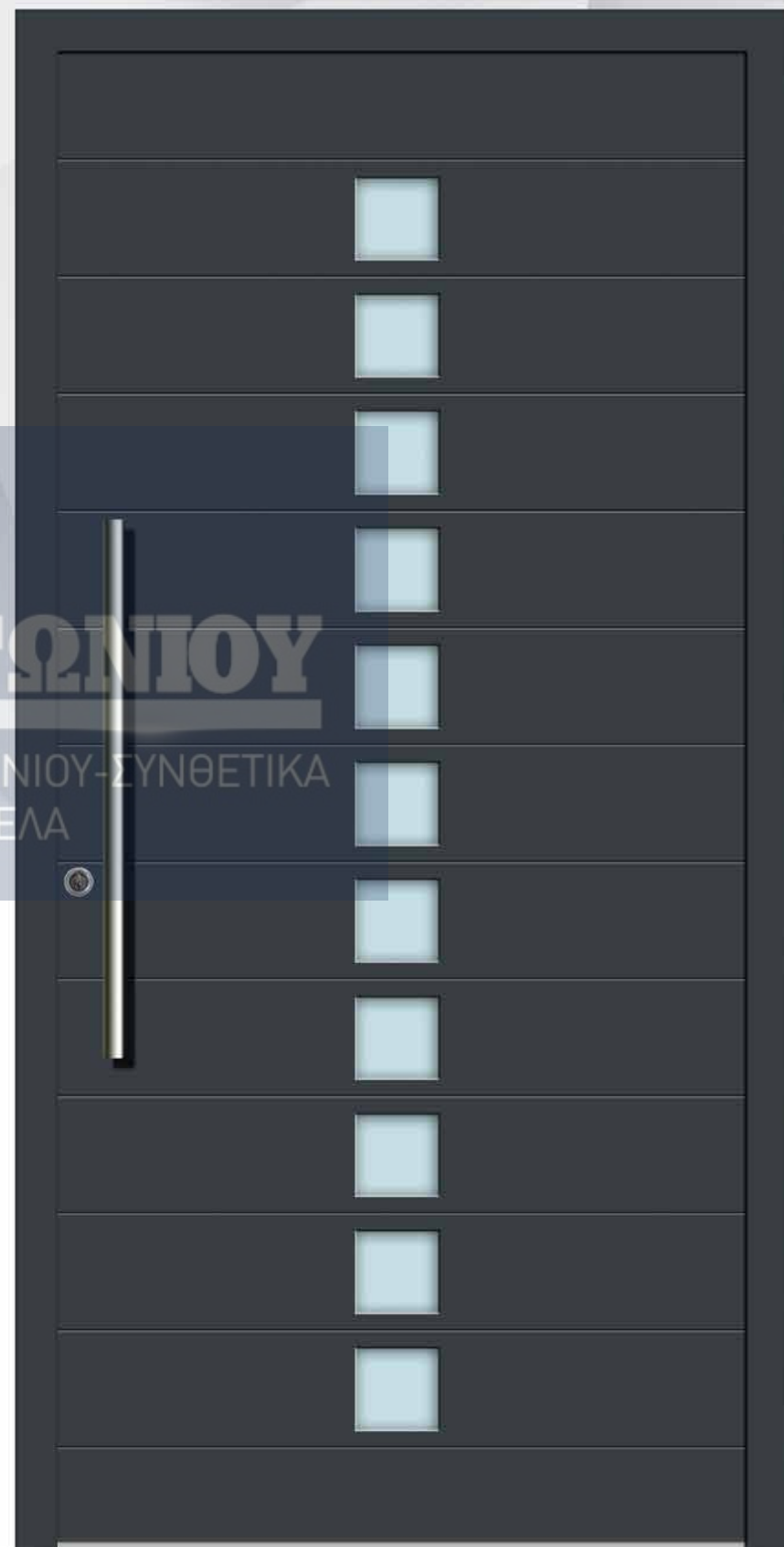

VO350
ELEGRAND | AVANTAGE LINE

ΕΛ. ΕΜ. ΑΝΤΩΝΙΟΥ
ΚΟΥΦΩΜΑΤΑ ΑΛΟΥΜΙΝΙΟΥ-ΣΥΝΘΕΤΙΚΑ
ΠΑΡΑΔΟΣΙΑΚΑ ΚΑΓΚΕΛΑ

ELEGRAND LINE



VO351
ELEGRAND | AVANTAGE LINE



VO361
ELEGRAND | AVANTAGE LINE

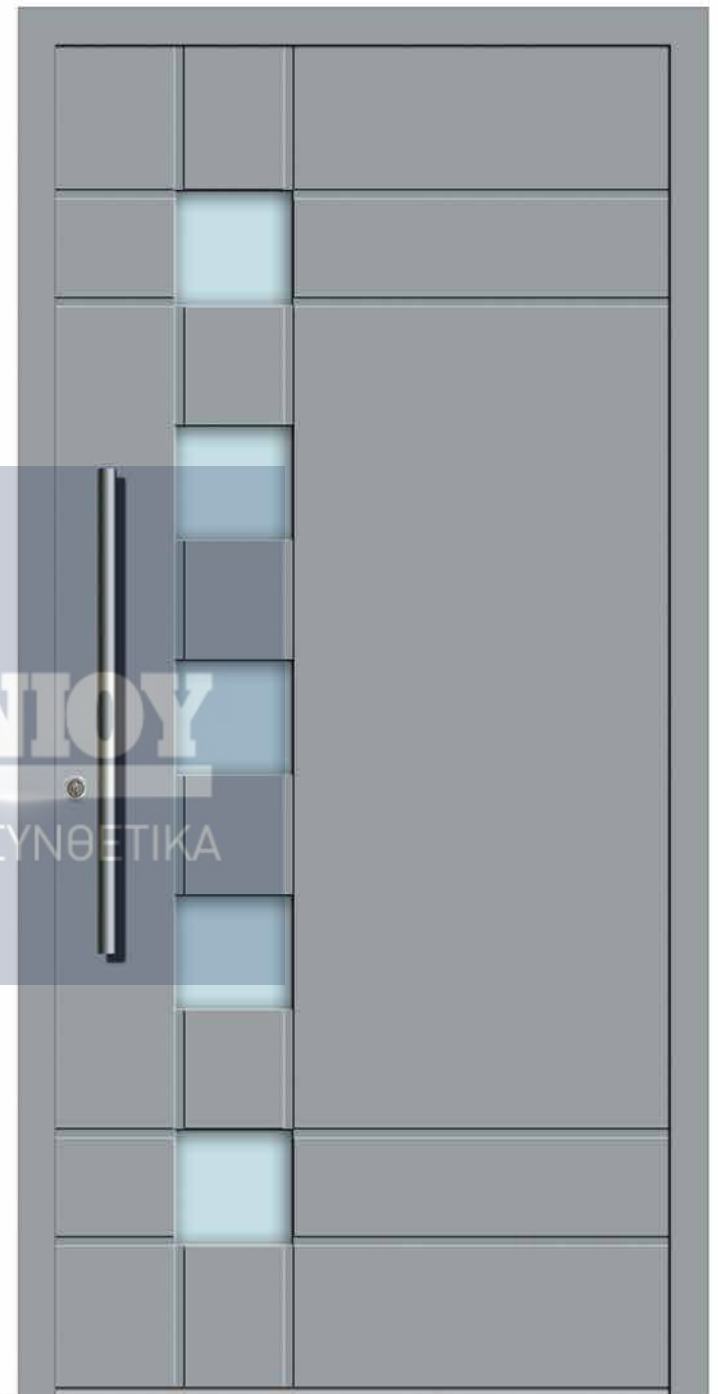

VO391
ELEGRAND | AVANTAGE LINE

ΕΛΕΜ ΑΝΤΩΝΙΟΥ

ΚΟΥΦΩΜΑΤΑ ΑΛΟΥΜΙΝΙΟΥ-ΣΥΝΘΕΤΙΚΑ
ΠΑΡΑΔΟΣΙΑΚΑ ΚΑΓΚΕΛΑ



ΕΛ.ΕΜ. ΑΝΤΩΝΙΟΥ
ΚΟΥΦΩΜΑΤΑ ΑΛΟΥΜΙΝΙΟΥ-ΣΥΝΘΕΤΙΚΑ
ΠΑΡΑΔΟΣΙΑΚΑ ΚΑΓΚΕΛΑ



VO411

ELEGRAND | AVANTAGE LINE

**ELEGRAND
LINE**



V1250
ELEGRAND | AVANTAGE LINE



VO431
ELEGRAND | AVANTAGE LINE



VO491
ELEGRAND | AVANTAGE LINE

ΕΛ. ΕΜ. ΑΝΤΩΝΙΟΥ
ΚΟΥΦΩΜΑΤΑ ΑΛΟΥΜΙΝΙΟΥ-ΣΥΝΘΕΤΙΚΑ
ΠΑΡΑΔΟΣΙΑΚΑ ΚΑΓΚΕΛΑ

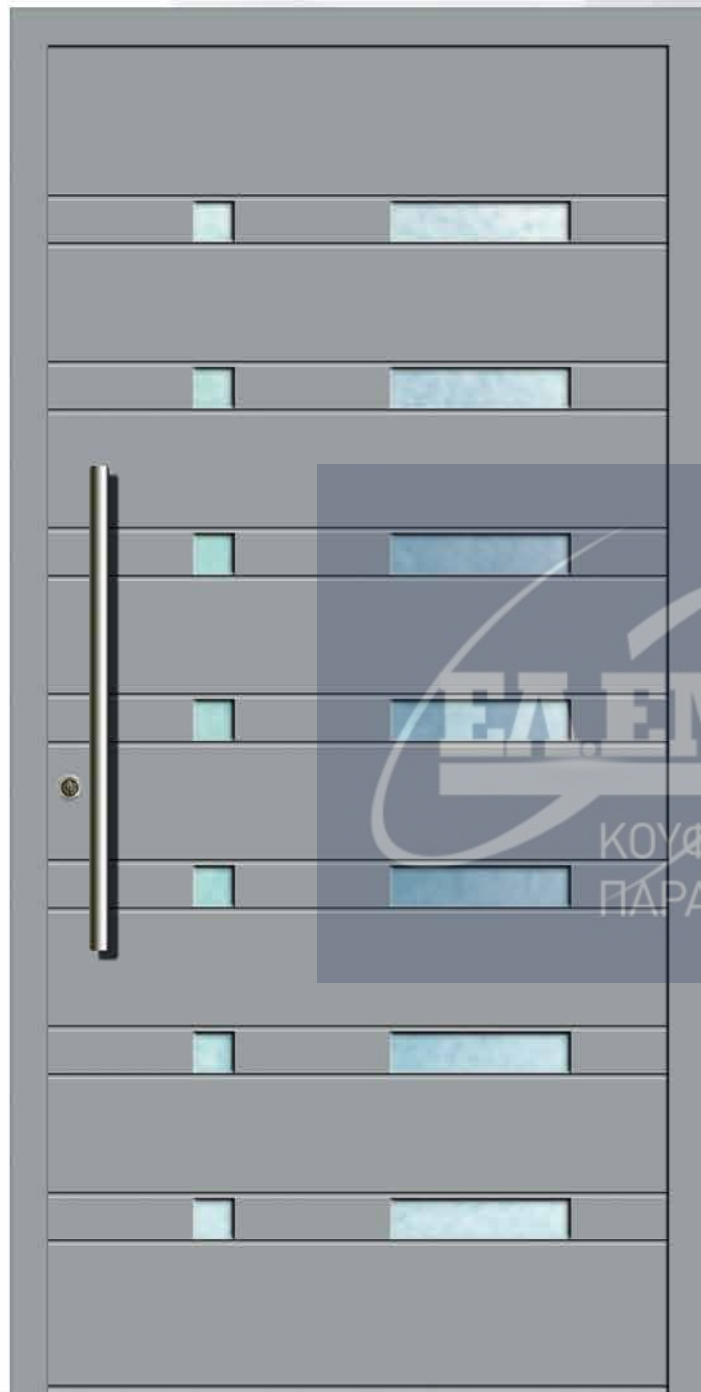

V0550

ELEGRAND | AVANTAGE LINE



V1240

ELEGRAND | AVANTAGE LINE

ΕΛ.ΕΜ. ΑΝΤΩΝΙΟΥ
ΚΟΥΦΩΜΑΤΑ ΑΛΟΥΜΙΝΙΟΥ-ΣΥΝΘΕΤΙΚΑ
ΠΑΡΑΔΟΣΙΑΚΑ ΚΑΓΚΕΛΑ

ELEGRAND
LINE

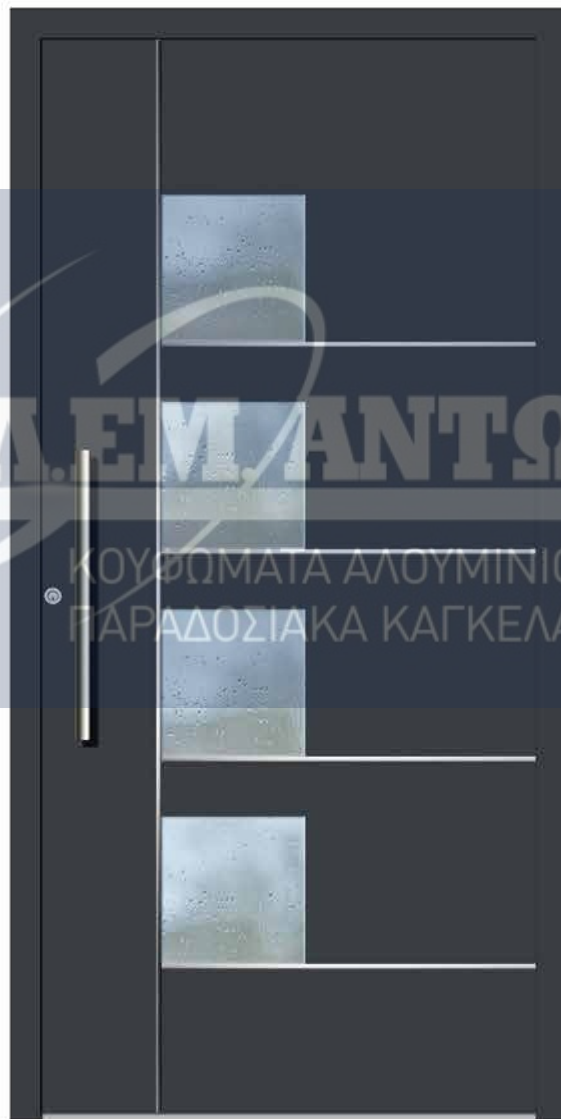
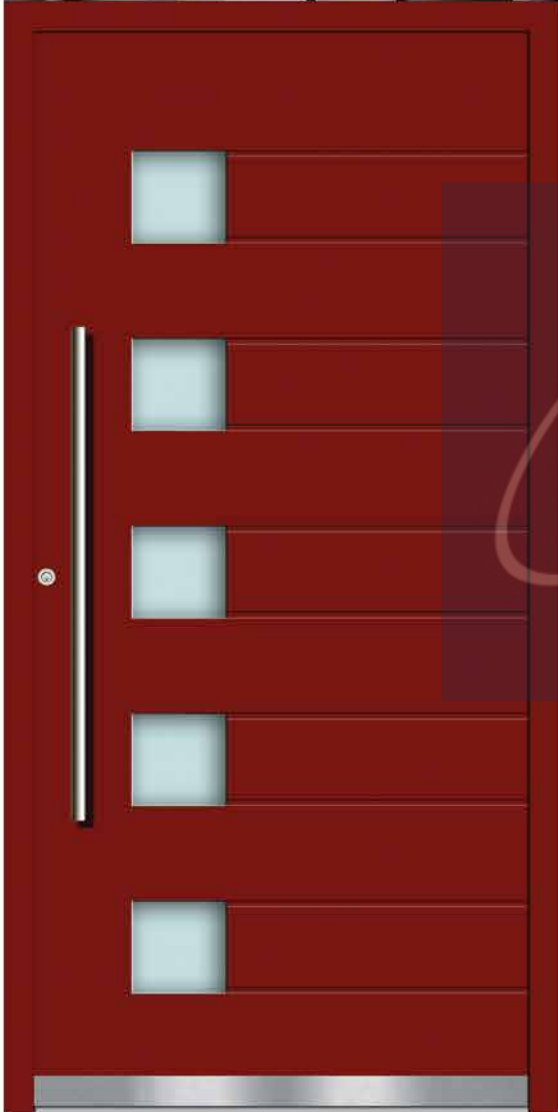

ΕΛ.ΕΜ.ΑΝΤΩΝΙΟΥ
ΚΟΥΦΩΜΑΤΑ ΑΛΟΥΜΙΝΙΟΥ-ΣΥΝΘΕΤΙΚΑ
ΠΑΡΑΔΟΣΙΑΚΑ ΚΑΓΚΕΛΑ

V0270
ELEGRAND | AVANTAGE LINE

V0510
ELEGRAND | AVANTAGE LINE

V1420
ELEGRAND | AVANTAGE LINE

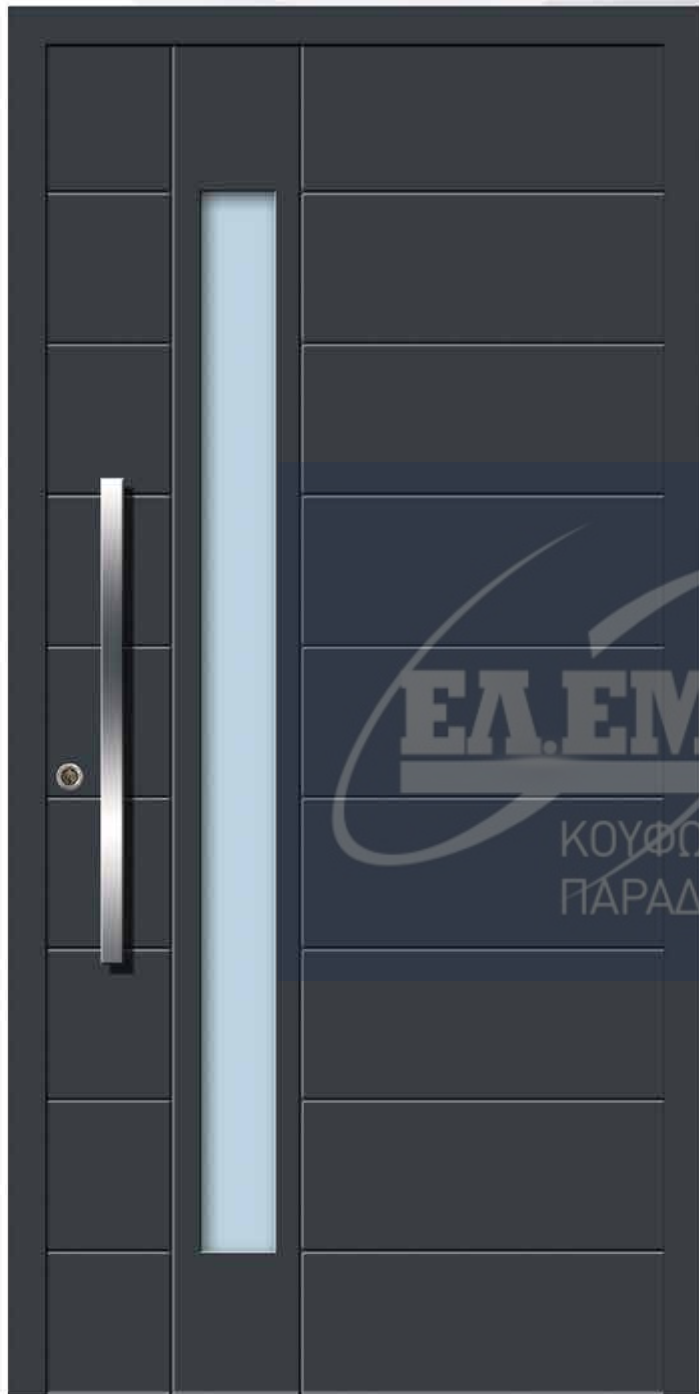

V1500
ELEGRAND | AVANTAGE LINE



V0580
ELEGRAND | AVANTAGE LINE

ΕΛ.ΕΜ. ΑΝΤΩΝΙΟΥ
ΚΟΥΦΩΜΑΤΑ ΑΛΟΥΜΙΝΙΟΥ-ΣΥΝΘΕΤΙΚΑ
ΠΑΡΑΔΟΣΙΑΚΑ ΚΑΓΚΕΛΑ

ELEGRAND
LINE



V1260
ELEGRAND | AVANTAGE LINE



V1270
ELEGRAND | AVANTAGE LINE



V1280
ELEGRAND | AVANTAGE LINE

ΕΛΕΜ. ΑΝΤΩΝΙΟΥ
ΚΟΥΦΩΜΑΤΑ ΑΛΟΥΜΙΝΙΟΥ-ΣΥΝΘΕΤΙΚΑ
ΠΑΡΑΔΟΣΙΑΚΑ ΚΑΓΚΕΛΑ



VERPAN

PREMIUM DESIGN



ΕΛ.ΕΜ. ΑΝΤΩΝΙΟΥ
ΚΟΥΦΩΜΑΤΑ ΑΛΟΥΜΙΝΙΟΥ-ΣΥΝΘΕΤΙΚΑ
ΠΑΡΑΔΟΣΙΑΚΑ ΚΑΓΚΕΛΑ



V1310

ELEGRAND | AVANTAGE LINE

VERPAN | ELEGANT TRADITIONALLINE



ΕΛΕΜ. ΑΝΤΩΝΙΟΥ

ΚΟΥΦΩΜΑΤΑ ΑΛΟΥΜΙΝΙΟΥ-ΣΥΝΘΕΤΙΚΑ
ΠΑΡΑΔΟΣΙΑΚΑ ΚΑΓΚΕΛΑ





ELEGRAND TRADITIONALLINE

Your romantic traditional home
needs an everlasting beauty!!!

ΕΛ.ΕΜ.ΑΝΤΩΝΙΟΥ
ΚΟΥΦΩΜΑΤΑ ΑΛΟΥΜΙΝΙΟΥ-ΣΥΝΘΕΤΙΚΑ
ΠΑΡΑΔΟΣΙΑΚΑ ΚΑΓΚΕΛΑ

Traditional Handmade Entrance door to last through time.

ELEGRAND
TRADITIONALLINE

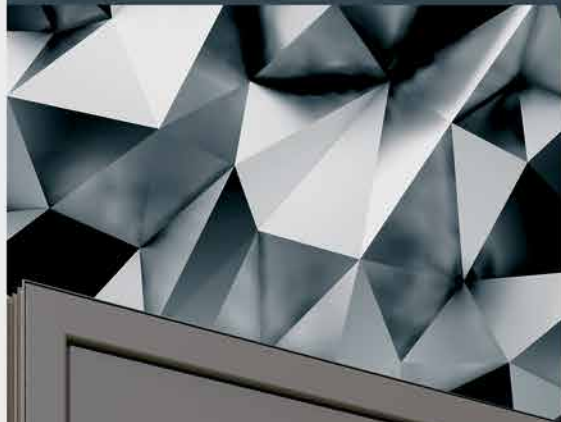

V1030
ELEGRAND | AVANTAGE LINE

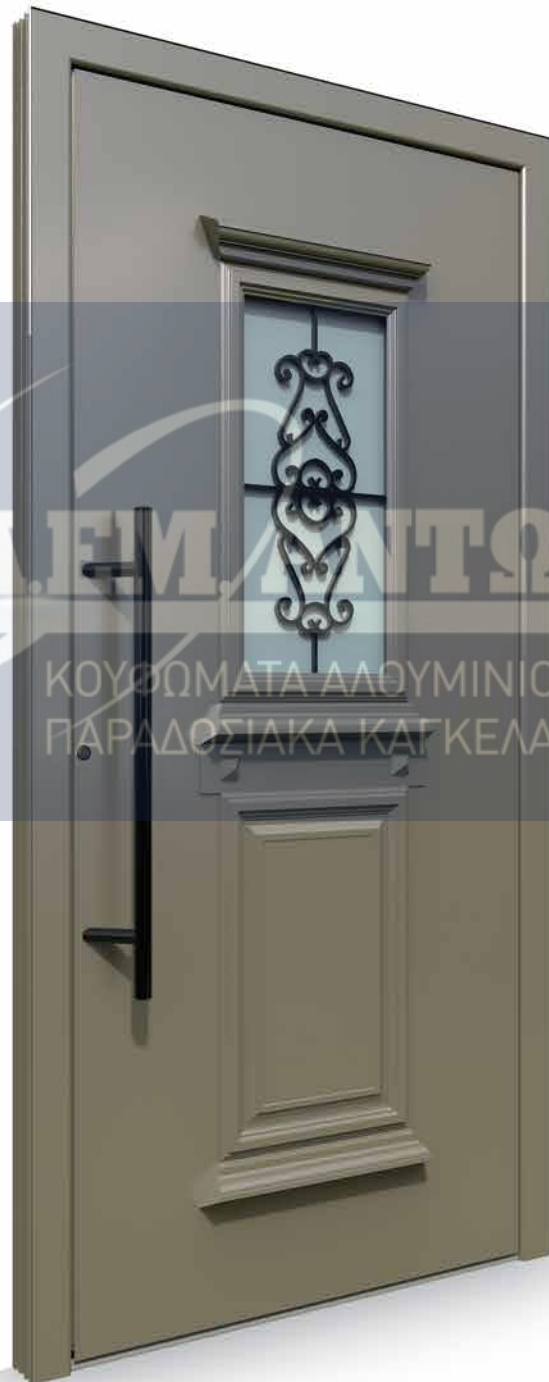

V1031
ELEGRAND | AVANTAGE LINE



V1060
ELEGRAND | AVANTAGE LINE

ΕΛΕΜ ΑΝΤΩΝΙΟΥ
ΚΟΥΦΩΜΑΤΑ ΑΛΟΥΜΙΝΙΟΥ-ΣΥΝΘΕΤΙΚΑ
ΠΑΡΑΔΟΣΙΑΚΑ ΚΑΓΚΕΛΑ



V1063
ELEGAND | AVANTAGE LINE



ΕΛ. ΕΜ. ΑΝΤΩΝΙΟΥ
ΚΟΥΦΩΜΑΤΑ ΑΛΟΥΜΙΝΙΟΥ-ΣΥΝΘΕΤΙΚΑ
ΠΑΡΑΔΟΣΙΑΚΑ ΚΑΤΕΡΑ

ELEGRAND
TRADITIONALLINE



V1100
ELEGRAND | AVANTAGE LINE



V0530
ELEGRAND | AVANTAGE LINE



V0534
ELEGRAND | AVANTAGE LINE

ΕΛΛΗΝΑΝΤΩΝΙΟΥ
ΚΟΥΦΩΜΑΤΑ ΑΛΟΥΜΙΝΙΟΥ-ΣΥΝΘΕΤΙΚΑ
ΠΑΡΑΔΟΣΙΑΚΑ ΚΑΓΚΕΛΑ



V1101
ELEGRAND | AVANTAGE LINE

ELEGRANDLINE

STANDARD EQUIPMENT

Both - sided sash overlapping panel 78.2mm. Aluminium thickness 2mm and 1mm. Inox ornaments on the same level with alu sheets.

- > **3 hinges** 2D
- > **Inside handle** Inox ID-20
- > **Outside Handle Round**
inox 800 mm placed on sash
- > **Glazing** 3 glasses, 4+4+4
- > **Simple cylinder** with three keys
- > **Rosette ring**
- > **3 point** security door locking system with hooks
- > **Anodised Threshold**
- > **Ud = 0.98 W/m²K**

ΕΛ.ΕΜ. ΑΝΤΩΝΙΟΥ

ΚΟΥΦΩΜΑΤΑ ΑΛΟΥΜΙΝΙΟΥ-ΣΥΝΘΕΤΙΚΑ
ΠΑΡΑΔΟΣΙΑΚΑ ΚΑΓΚΕΛΑ

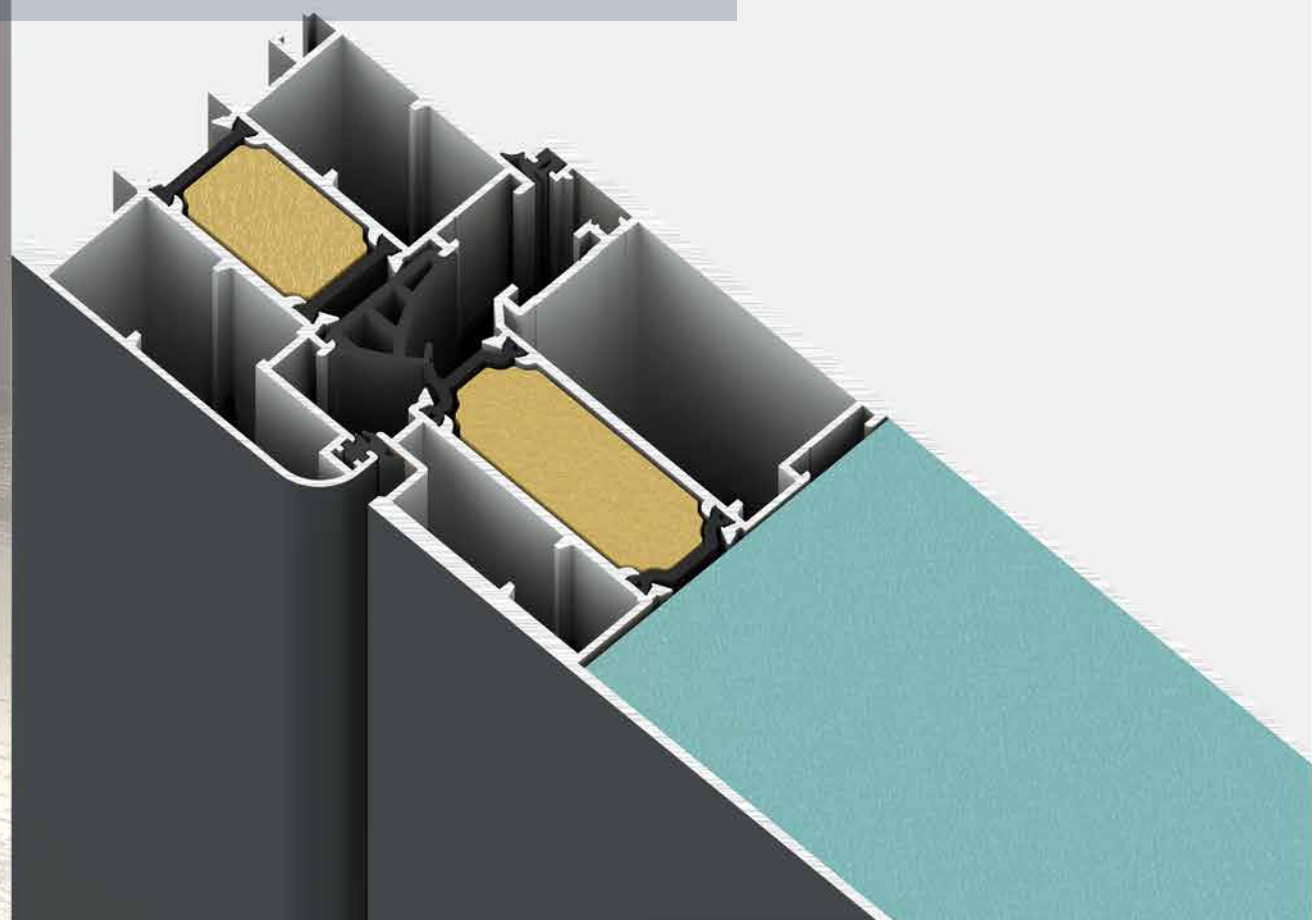

STANDARD EQUIPMENT

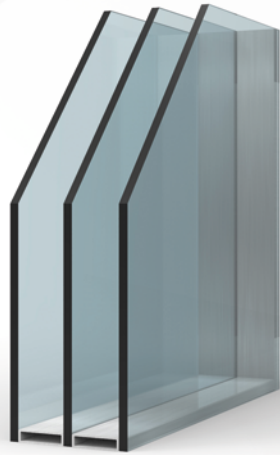

3 glasses 4+4+4



Simple cylinder
EX-206



Round rosette
EX-900



2D Hinge
EX-305



Inside Handle ID-20
EX-500



OUTSIDE HANDLE 800MM
V175.30.800

3 point hooklock

EX-100

VERTICAL SECTION

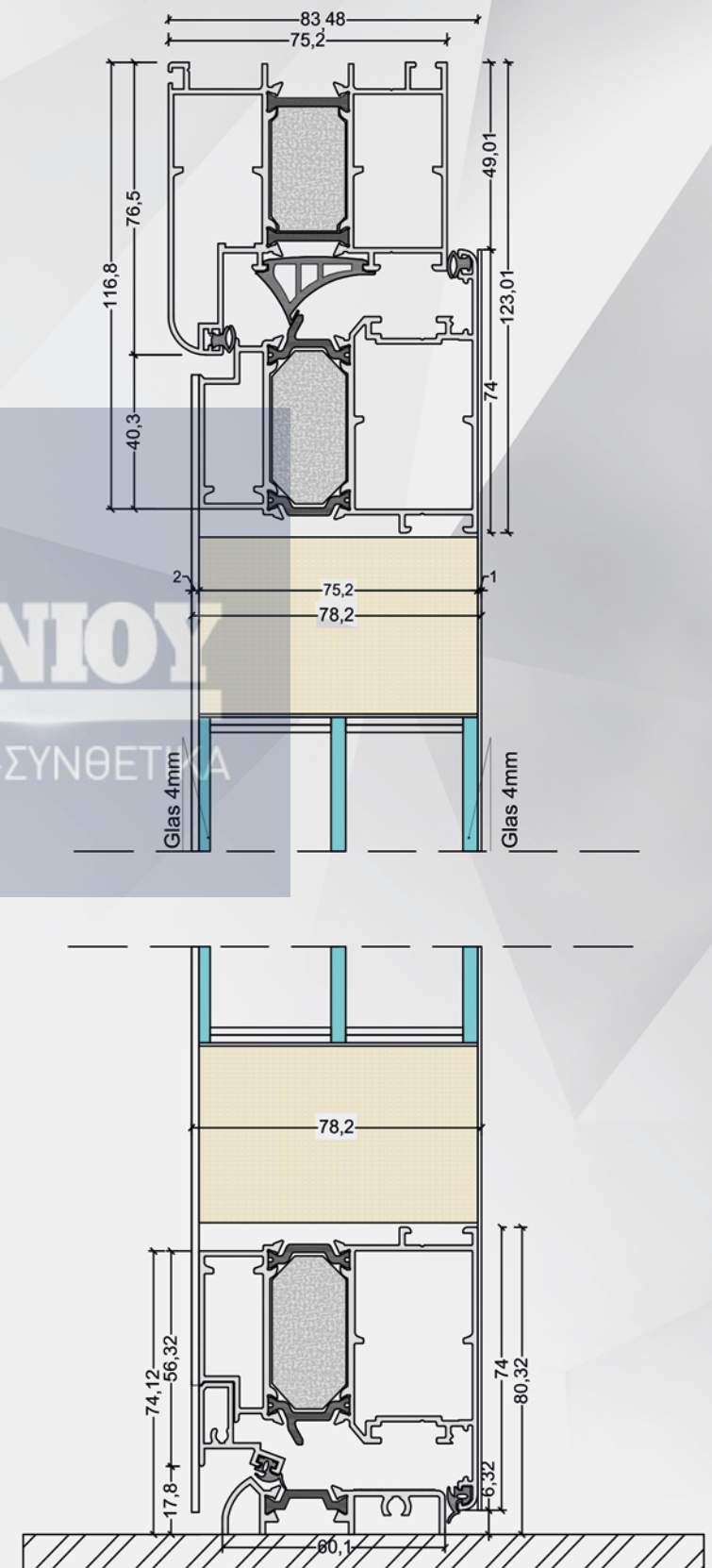

ΕΛ.ΕΜ. ΑΝΤΩΝΙΟΥ

ΚΟΥΦΩΜΑΤΑ ΑΛΟΥΜΙΝΙΟΥ-ΣΥΝΘΕΤΙΚΑ
ΠΑΡΑΔΟΣΙΑΚΑ ΚΑΓΚΕΛΑ

VERPAN | COMPACTLINE



YDM1109+

ΕΛ. ΕΜ. ΑΝΤΩΝΙΟΥ

ΚΟΥΦΩΜΑΤΑ ΑΛΟΥΜΙΝΙΟΥ-ΣΥΝΘΕΤΙΚΑ
ΠΑΡΑΔΟΣΙΑΚΑ ΚΑΓΚΕΛΛΑ

COMPACTLINE

A solution for you!



Simple and beautiful!!!

**COMPACT
LINE**

ΕΛ.ΕΜ.ΑΝΤΩΝΙΟΥ

ΚΟΥΦΩΜΑΤΑ ΑΛΟΥΜΙΝΙΟΥ-ΣΥΝΘΕΤΙΚΑ
ΠΑΡΑΔΟΣΙΑΚΑ ΚΑΓΚΕΛΑ





V0100
COMPACT | AVANTAGE
ELEGRAND LINE



V0110
COMPACT | AVANTAGE
ELEGRAND LINE

ΕΛ.ΕΜ. ΑΝΤΩΝΙΟΥ
ΚΟΥΦΩΜΑΤΑ ΑΛΟΥΜΙΝΙΟΥ-ΣΥΝΘΕΤΙΚΑ
ΠΑΡΑΔΟΣΙΑΚΑ ΚΑΓΚΕΛΑ

COMPACT
LINE



ΕΛ.ΕΜ.ΑΝΤΩΝΙΟΥ
ΚΟΥΦΩΜΑΤΑ ΑΛΟΥΜΙΝΙΟΥ-ΣΥΝΘΕΤΙΚΑ
ΠΑΡΑΔΟΣΙΑΚΑ ΚΑΓΚΕΛΑ

Vo111
COMPACT | AVANTAGE
ELEGRAND | ECO LINE

Vo131
COMPACT
AVANTAGE | ECO LINE

Vo160
COMPACT | ELEGRAND LINE



ΕΛ.ΕΜ. ΑΝΤΩΝΙΟΥ
ΚΟΥΦΩΜΑΤΑ ΑΛΟΥΜΙΝΙΟΥ-ΣΥΝΘΕΤΙΚΑ
ΠΑΡΑΔΟΣΙΑΚΑ ΚΑΓΚΕΛΑ

VO101

COMPACT | ELEGRAND LINE



**COMPACT
LINE**



ΕΛΕΝΤΑΝΤΩΝΙΟΥ
ΚΟΥΦΩΜΑΤΑ ΑΛΟΥΜΙΝΙΟΥ-ΣΥΝΘΕΤΙΚΑ
ΠΑΡΑΛΟΣΙΑΚΑ ΚΑΓΚΕΛΑ



Vo190
COMPACT | AVANTAGE
ELEGRAND LINE



VO200

COMPACT | AVANTAGE
ELEGAND | ECO LINE



VO222

COMPACT | ELEGAND LINE

ΕΛ.ΕΜ. ΑΝΤΩΝΙΟΥ
ΚΟΥΦΩΜΑΤΑ ΑΛΟΥΜΙΝΙΟΥ-ΣΥΝΘΕΤΙΚΑ
ΠΑΡΑΔΟΣΙΑΚΑ ΚΑΓΚΕΛΑ

**COMPACT
LINE**

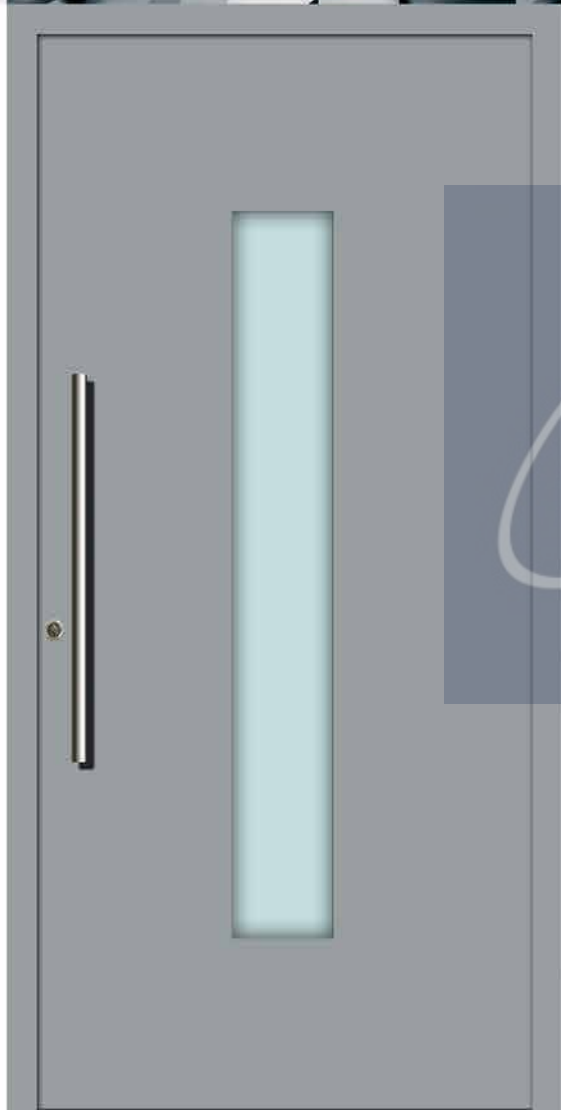

Vo261
COMPACT | ELEGRAND LINE



Vo280
COMPACT
ELEGRAND | ECO LINE

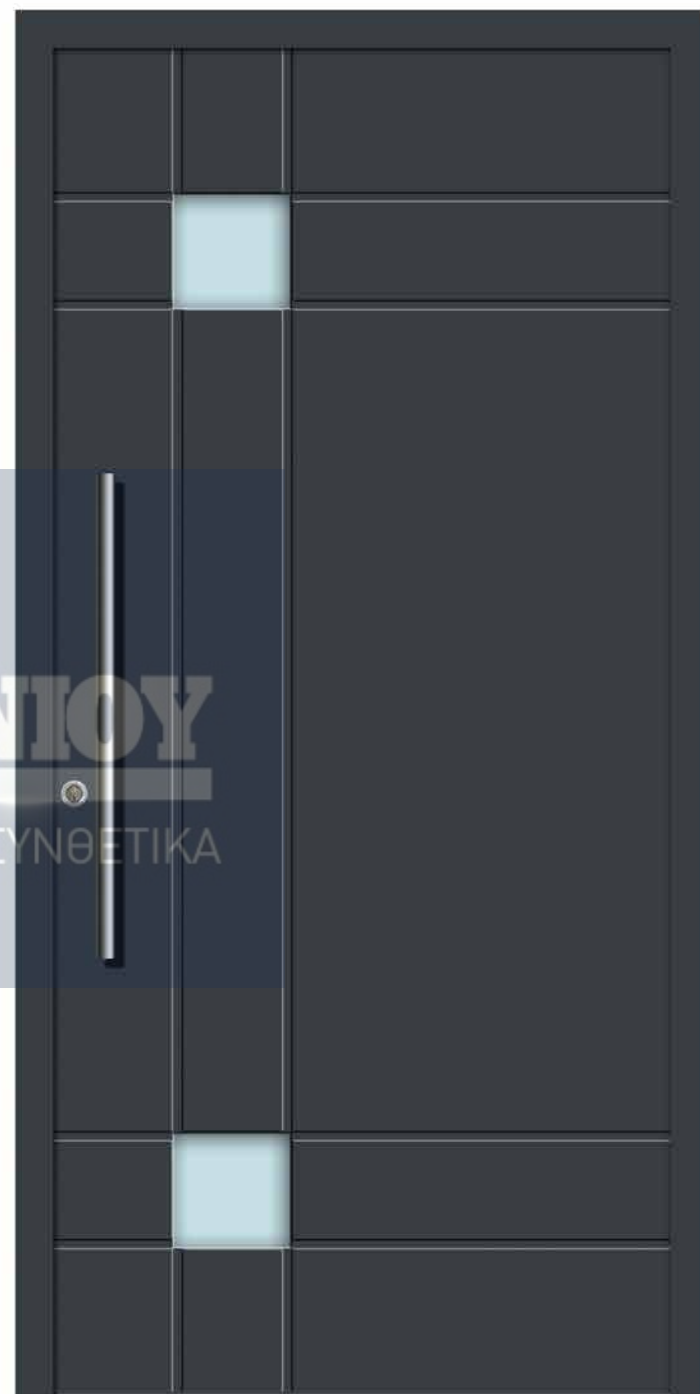

Vo392
COMPACT | AVANTAGE
ELEGRAND LINE

ΕΛ.ΕΜ. ΑΝΤΩΝΙΟΥ
ΚΟΥΦΩΜΑΤΑ ΑΛΟΥΜΙΝΙΟΥ-ΣΥΝΘΕΤΙΚΑ
ΠΑΡΑΔΟΣΙΑΚΑ ΚΑΓΚΕΛΑ



ΕΛ.ΕΜ. ΑΝΤΩΝΙΟΥ

ΚΟΥΦΩΜΑΤΑ ΑΛΟΥΜΙΝΙΟΥ-ΣΥΝΘΕΤΙΚΑ
ΠΑΡΑΔΟΣΙΑΚΑ ΚΑΓΚΕΛΑ

Vo581

COMPACT | ELEGRAND | ECO LINE

COMPACT
LINE

ΕΛ.ΕΜ. ΑΝΤΩΝΙΟΥ

ΚΟΥΦΩΜΑΤΑ ΑΛΟΥΜΙΝΙΟΥ-ΣΥΝΘΕΤΙΚΑ
ΠΑΡΑΔΟΣΙΑΚΑ ΚΑΓΚΕΛΑ



V1340

COMPACT | ELEGRAND | ECO LINE



V1380
COMPACT | ELEGRAND LINE

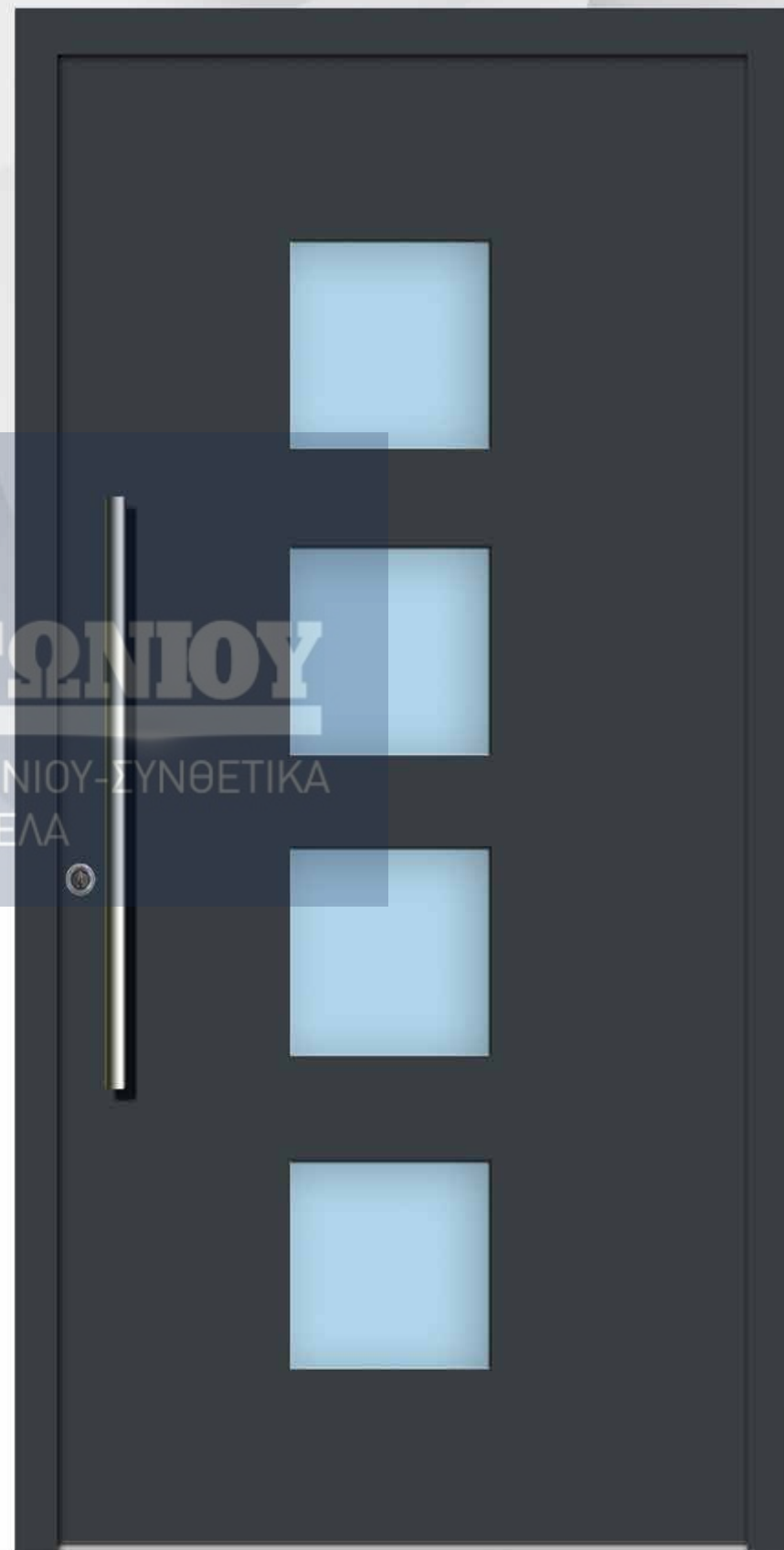

V1430
COMPACT | ELEGRAND LINE

ΕΛ.ΕΜ. ΑΝΤΩΝΙΟΥ
ΚΟΥΦΩΜΑΤΑ ΑΛΟΥΜΙΝΙΟΥ-ΣΥΝΘΕΤΙΚΑ
ΠΑΡΑΔΟΣΙΑΚΑ ΚΑΓΚΕΛΑ

COMPACTLINE

STANDARD EQUIPMENT

Both - sided sash overlapping panel 69.1mm. Aluminium thickness 1.5mm and 1.5mm. Inox ornaments above the level of alu sheets.

- > **3 hinges** 2D
- > **Inside handle** Inox ID-20
- > **Outside Handle Round**
inox 400 mm placed on sash
- > **Glazing** 3 glasses, 4+4+4
- > **Simple cylinder** with three keys
- > **Rosette ring**
- > **1 point** locking system
- > **Anodised Threshold**
- > **Ud = 0.96 W/m²K**

ΕΛ.ΕΜ. ΑΝΤΩΝΙΟΥ

ΚΟΥΦΩΜΑΤΑ ΑΛΟΥΜΙΝΙΟΥ-ΣΥΝΘΕΤΙΚΑ
ΠΑΡΑΔΟΣΙΑΚΑ ΚΑΓΚΕΛΑ

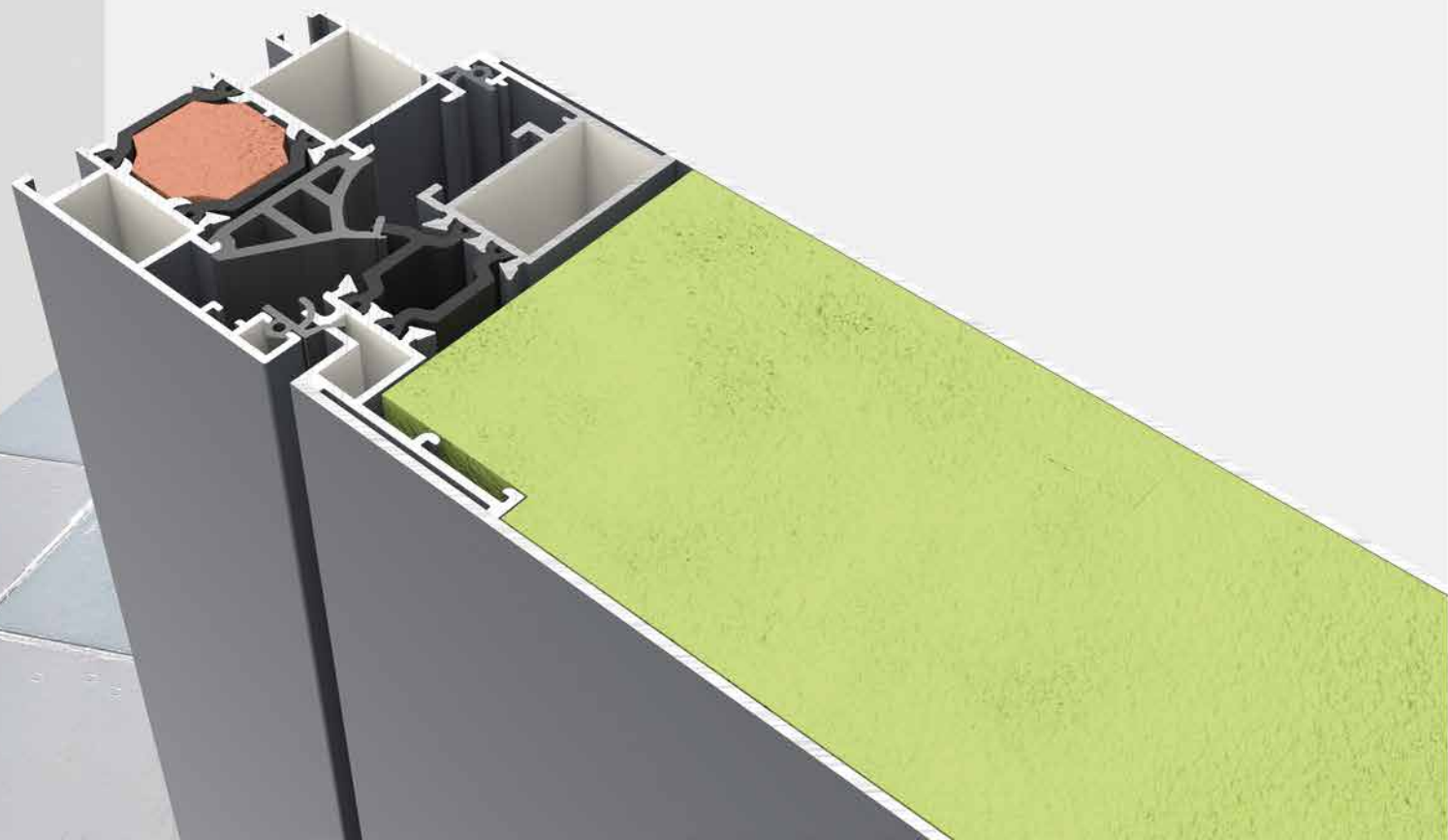

COMPACTLINE

STANDARD EQUIPMENT

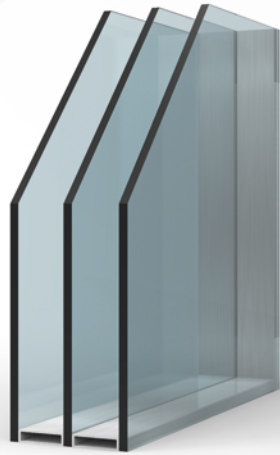

3 glasses 4+4+4



Simple cylinder
EX-206



Round rosette
EX-900



2D Hinge
EX-306



Inside Handle ID-20
EX-500



1 point lock
EX-107



OUTSIDE HANDLE 400MM
V175.30.400

VERTICAL SECTION

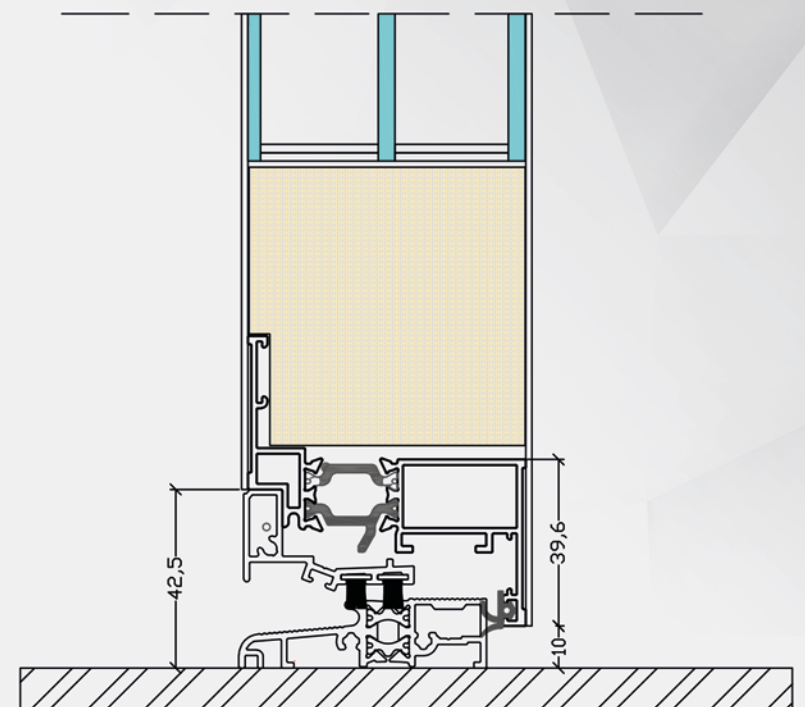
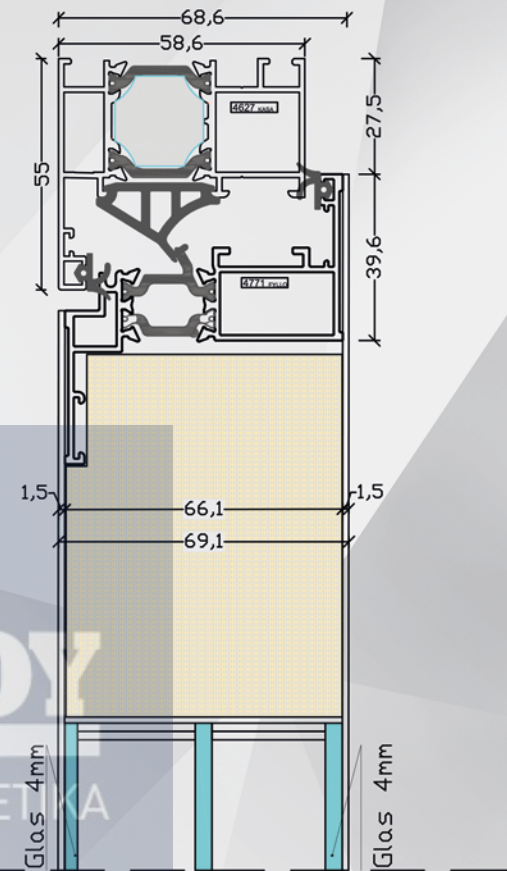

VERPA | ECOLINE

ΕΛ.ΕΜ.ΑΝΤΩΝΙΟΥ
ΚΟΥΦΩΜΑΤΑ ΑΛΟΥΜΙΝΙΟΥ-ΣΥΝΘΕΤΙΚΑ
ΠΑΡΑΔΟΣΙΑΚΑ ΚΑΓΚΕΛΑ





ECOLINE

Simple and free of exaggerations!

ΕΛ.ΕΜ.ΑΝΤΩΝΙΟΥ
ΚΟΥΦΩΜΑΤΑ ΑΛΟΥΜΙΝΙΟΥ-ΣΥΝΘΕΤΙΚΑ
ΠΑΡΑΔΟΣΙΑΚΑ ΚΑΓΚΕΛΑ

Simplicity of straight lines.

ECOLINE

ΕΛ.ΕΜ.ΑΝΤΩΝΙΟΥ

ΚΟΥΦΩΜΑΤΑ ΑΛΟΥΜΙΝΙΟΥ-ΣΥΝΘΕΤΙΚΑ
ΠΑΡΑΔΟΣΙΑΚΑ ΚΑΓΚΕΛΑ



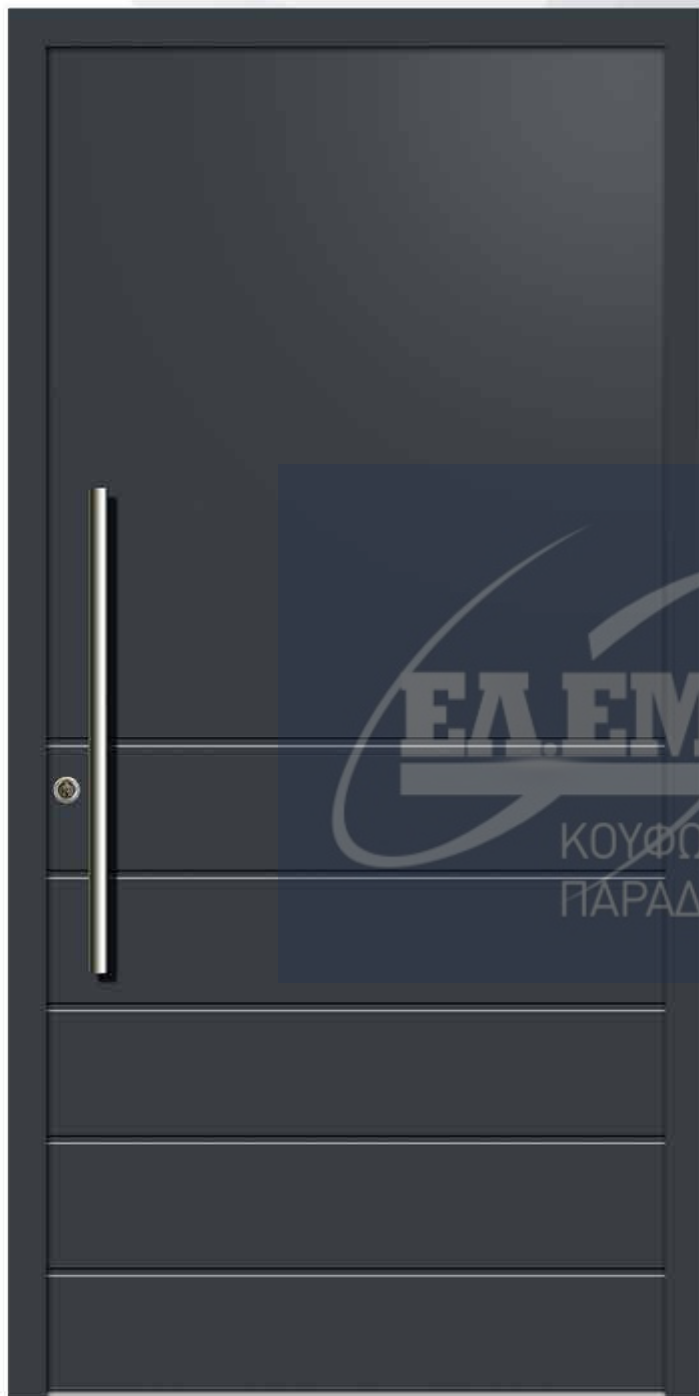

VO112

ECO | ELEGRAND | COMPACT LINE

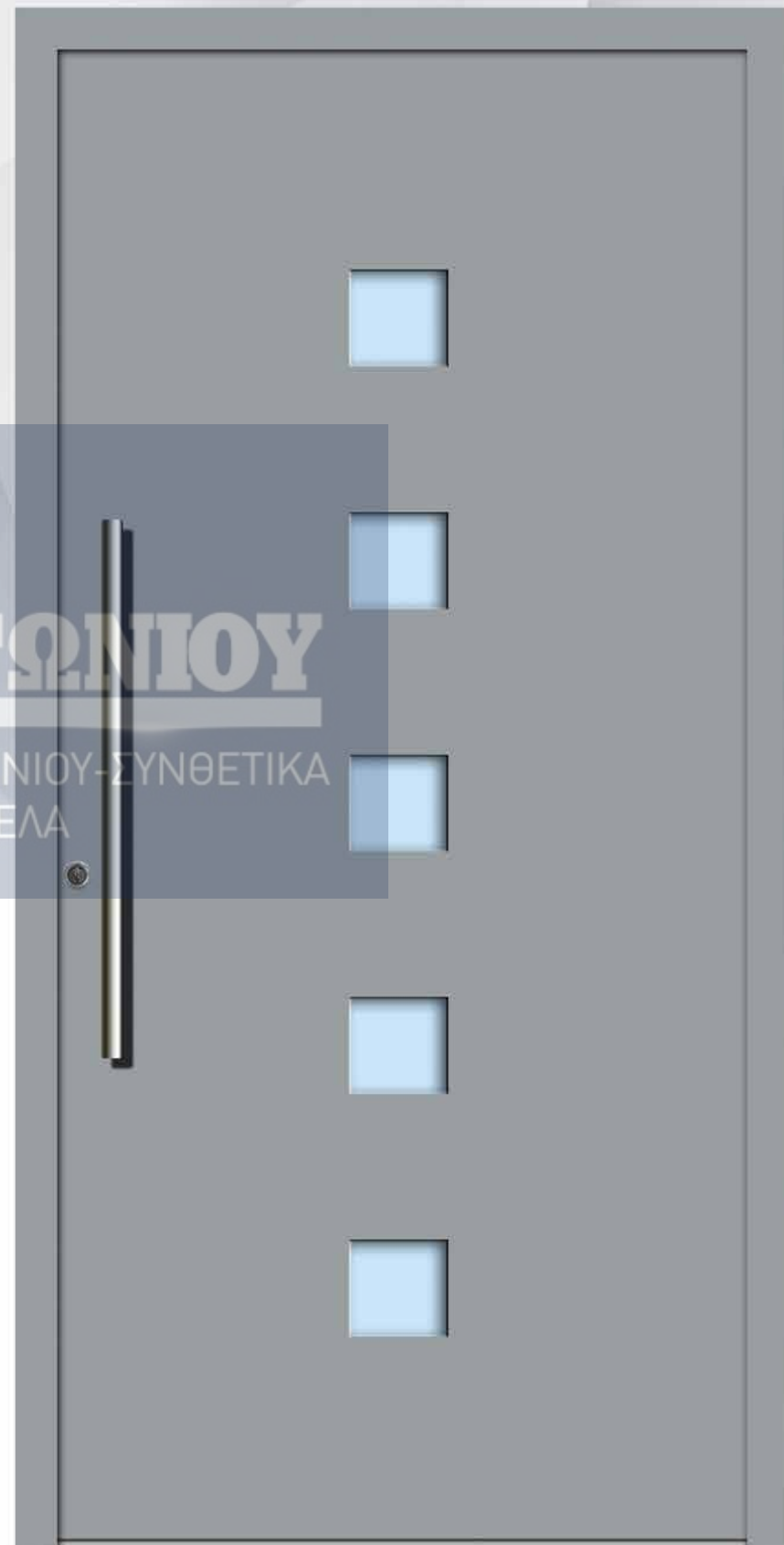

VO144

ECO | ELEGRAND | COMPACT LINE

ΕΛ.ΕΜ. ΑΝΤΩΝΙΟΥ
ΚΟΥΦΩΜΑΤΑ ΑΛΟΥΜΙΝΙΟΥ-ΣΥΝΘΕΤΙΚΑ
ΠΑΡΑΔΟΣΙΑΚΑ ΚΑΓΚΕΛΑ

ECOLINE

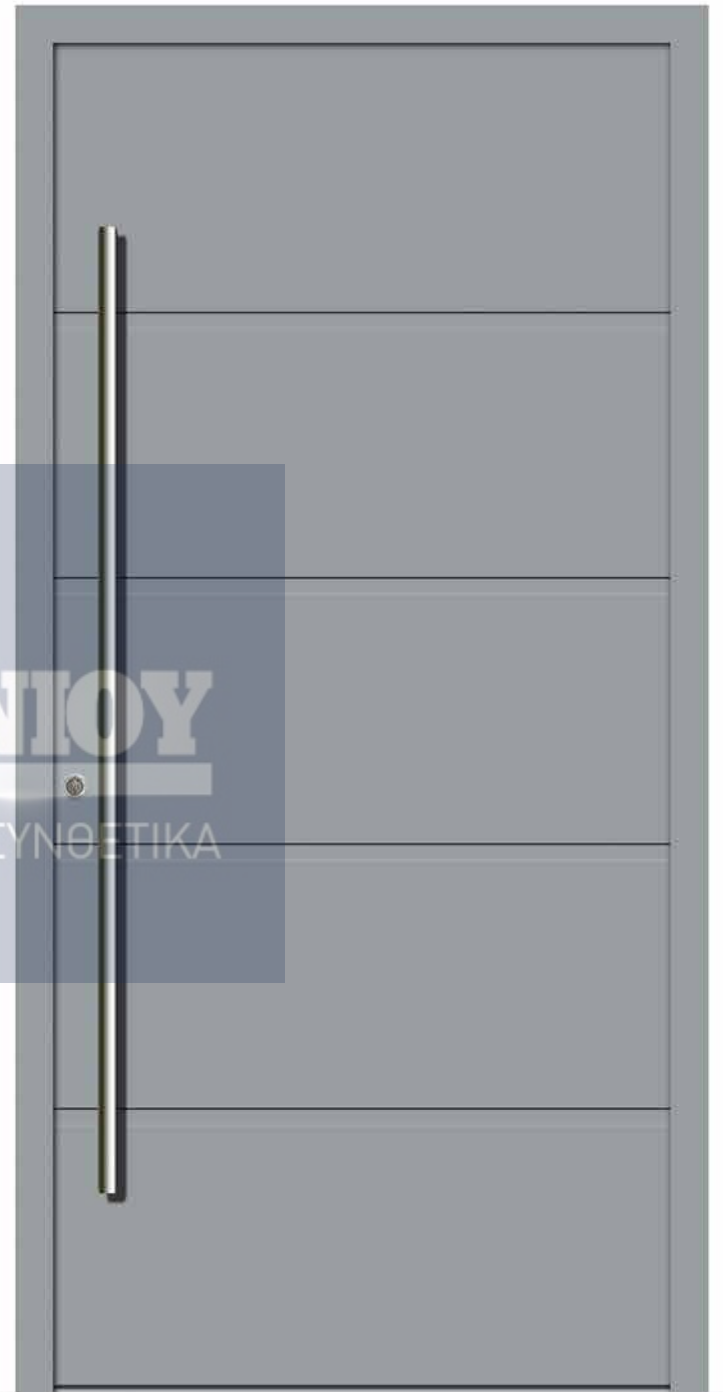

ΕΛ.ΕΜ.ΑΝΤΩΝΙΟΥ

ΚΟΥΦΩΜΑΤΑ ΑΛΟΥΜΙΝΙΟΥ-ΣΥΝΘΕΤΙΚΑ
ΠΑΡΑΔΟΣΙΑΚΑ ΚΑΓΚΕΛΑ

Vo130

ECO | AVANTAGE
ELEGRAND | COMPACT LINE

Vo311

ECO | AVANTAGE
ELEGRAND | COMPACT LINE

Vo360

ECO | ELEGRAND | COMPACT LINE

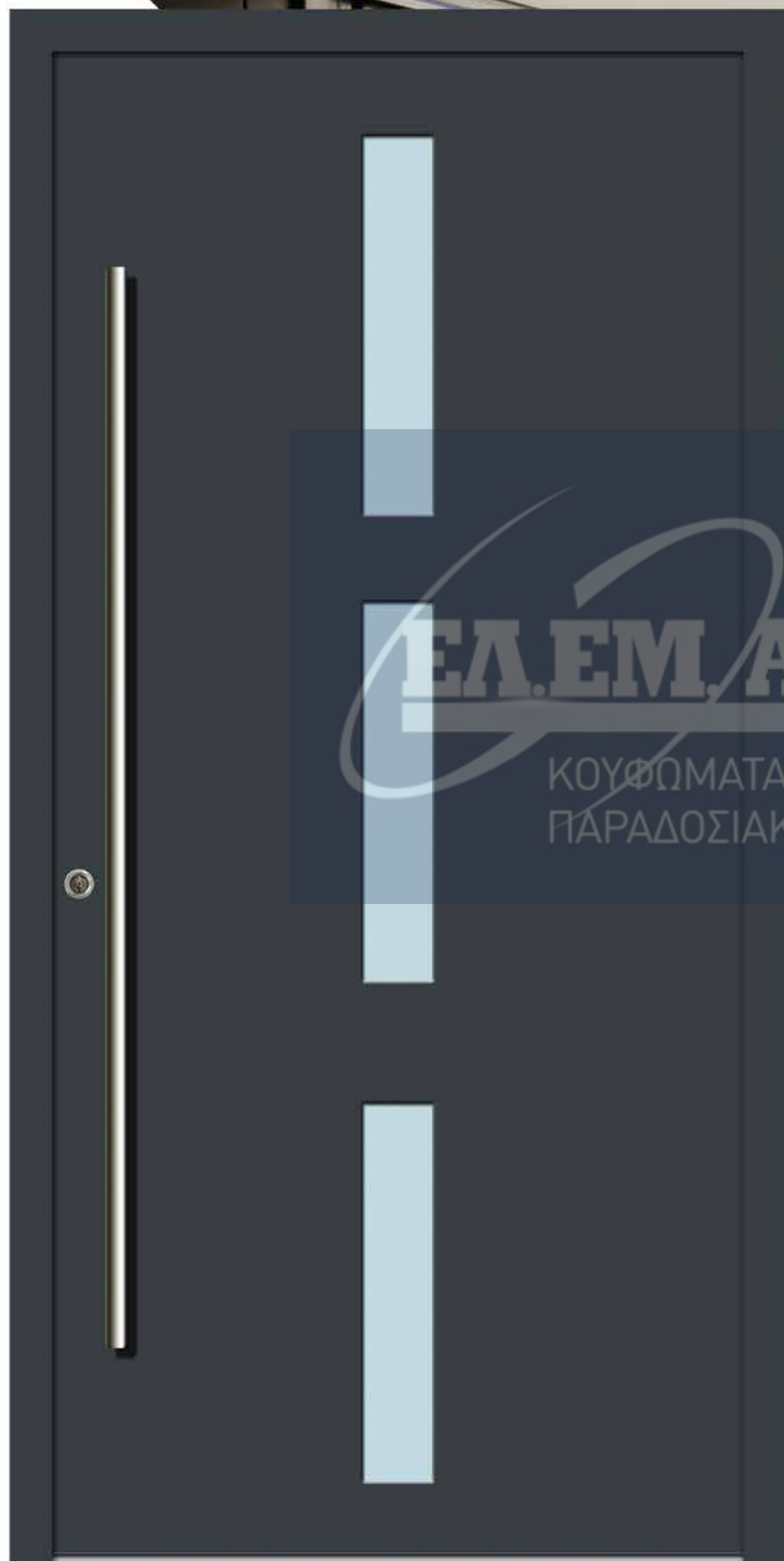

ΕΛ.ΕΜ. ΑΝΤΩΝΙΟΥ
ΚΟΥΦΩΜΑΤΑ ΑΛΟΥΜΙΝΙΟΥ ΣΥΝΘΕΤΙΚΑ
ΠΑΡΑΔΟΣΙΑΚΑ ΚΑΓΚΕΛΑ

VO440
ECO | COMPACT LINE

ECOLINE

STANDARD EQUIPMENT

Both - sided sash overlapping panel 64.3mm. Aluminium thickness 1.5mm and 1mm. Inox ornaments above the level of alu sheets.

- > **3 hinges**
- > **Inside handle** Inox ID-20
- > **Outside Handle Round**
inox 400 mm placed on sash
- > **Glazing** 3 glasses, 4+4+4
- > **Simple cylinder** with three keys
- > **Rosette**
- > **1 point** locking system
- > **Anodised Threshold**

ΕΛ.ΕΜ. ΑΝΤΩΝΙΟΥ

ΚΟΥΦΩΜΑΤΑ ΑΛΟΥΜΙΝΙΟΥ-ΣΥΝΘΕΤΙΚΑ
ΠΑΡΑΔΟΣΙΑΚΑ ΚΑΓΚΕΛΑ

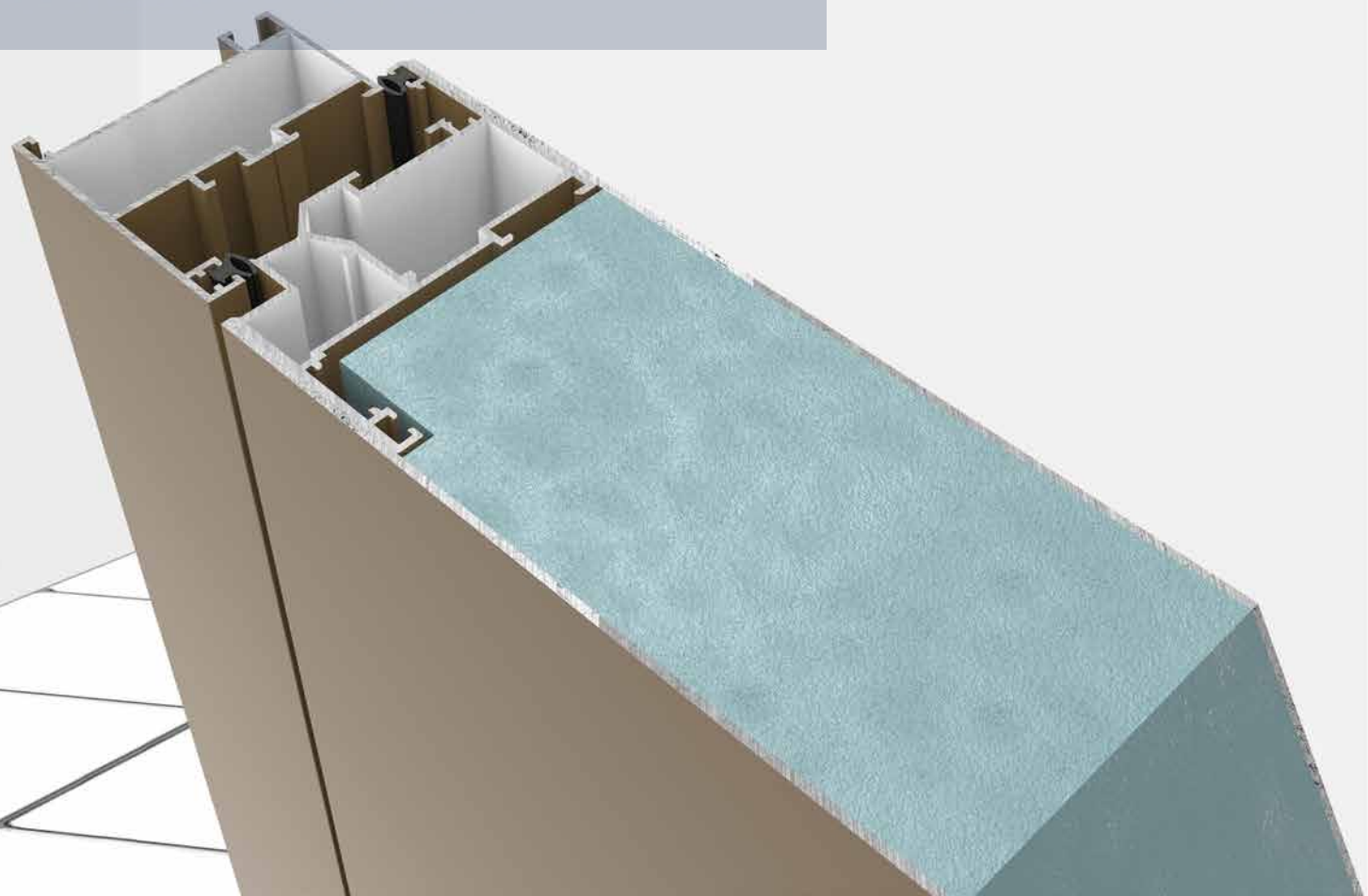

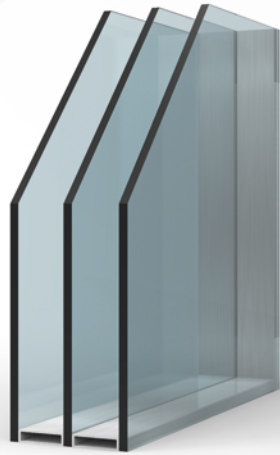

3 glasses 4+4+4



Simple cylinder
EX-206



Round rosette
EX-901



Eco Hinge
EX-307



Inside Handle ID-20
EX-500



1 point lock
EX-107



OUTSIDE HANDLE 400MM
V175.30.400

VERTICAL SECTION

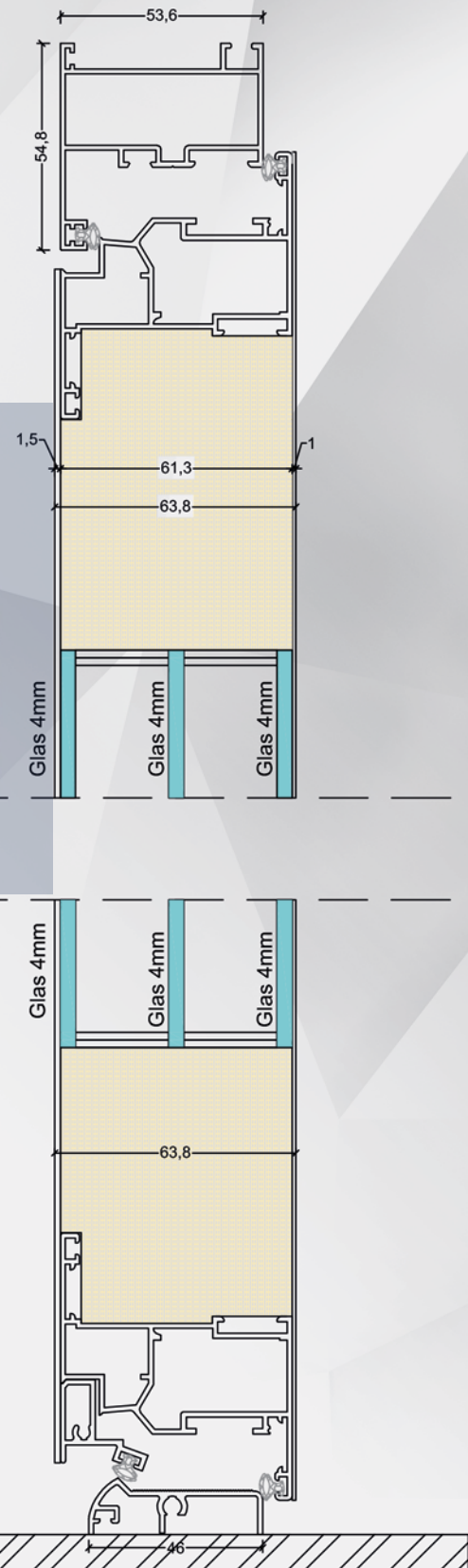

ΕΛΕΜ. ΑΝΤΩΝΙΟΥ
 ΠΡΟΦΟΡΜΑΤΑ ΑΛΟΥΜΙΝΙΟΥ-ΣΥΝΘΕΤΙΚΑ
 ΠΑΡΑΔΟΣΙΑΚΑ ΚΑΓΚΕΛΑ

EXTRA EQUIPMENT



Key Protection
EX-705



Key Protection
EX-704



Bluetooth
opening system
EX-402



Fingercan
opening system
EX-401



Keyboard
opening system
EX-403

V175 Round Handle on sash	
KQΔ / CODE	L (mm)
V175.30.400	400
V175.30.600	600
V175.30.800	800
V175.30.1000	1000
V175.30.1200	1200
V175.30.1400	1400
V175.30.1600	1600
V175.30.1800	1800



V170 Round Handle on panel	
KQΔ / CODE	L (mm)
V170.40.400	400
V170.40.600	600
V170.40.800	800
V170.40.1000	1000
V170.40.1200	1200
V170.40.1400	1400
V170.40.1600	1600
V170.40.1800	1800

ΚΟΥΦΟΜΑΤΑ ΑΛΟΥΜΙΝΙΟΥ ΣΥΝΘΕΤΙΚΑ
ΠΑΡΑΔΟΣΙΑΚΑ ΚΑΓΚΕΛΑ

V235 Angular Handle on sash	
KQΔ / CODE	L (mm)
V235.50.400	400
V235.50.600	600
V235.50.800	800
V235.50.1000	1000
V235.50.1200	1200
V235.50.1400	1400
V235.50.1600	1600
V235.50.1800	1800



V440 Angular Handle on panel	
KQΔ / CODE	L (mm)
V440.60.400	400
V440.60.600	600
V440.60.800	800
V440.60.1000	1000
V440.60.1200	1200
V440.60.1400	1400
V440.60.1600	1600
V440.60.1800	1800



V145 Arched Handle	
KQΔ / CODE	L (mm)
V145.80.500	500
V145.80.800	800
V145.80.1000	1000
V145.80.1200	1200
V145.80.1400	1400



V70 Angular Handle on sash with integrated finger scan	
KQΔ / CODE	L (mm)
V70.1200	1200



V90 / V90F (FINGERPRINT)	
KQΔ / CODE	L (mm)
V90	400
V90 F (Fingerprint)	400



V810 (L=826 D=400) Handle on panel	
KQΔ / CODE	L (mm)
V810	826



Foot protection - EX-707



Foot protection - EX-706

0 1 2 3 4 5 6 7 8 9

Numbers from stainless steel - EX-708

0 1 2 3 4 5 6 7 8 9

Numbers from glass inside panel - EX-709



V820 Hidden Handle in panel	
KQΔ / CODE	L (mm)
V820	200-2000

EXTRA EQUIPMENT

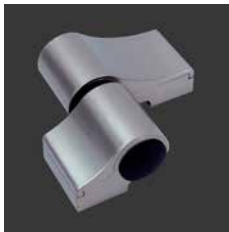

Hinge
EX-301



Hidden Hinge
EX-303



Hinge
EX-304



Hinges safety
EX-310



Safety Rosette
EX-902



Safety Rosette
EX-903



Safety Rosette
EX-904



Safety Rosette
EX-905



Cylinder with keys
in and out EX-203



Safety cylinder
EX-200



Electric strike
EX-400



Block (EX-105)
EX-409



Spyhole
EX-404



Spyhole with
camera EX-405



Door closer
EX-600



Door closer
EX-601



Inside Handle
ID 20 EX-500



Inside Handle
ID 30 EX-501



Inside Handle
ID 35 EX-502

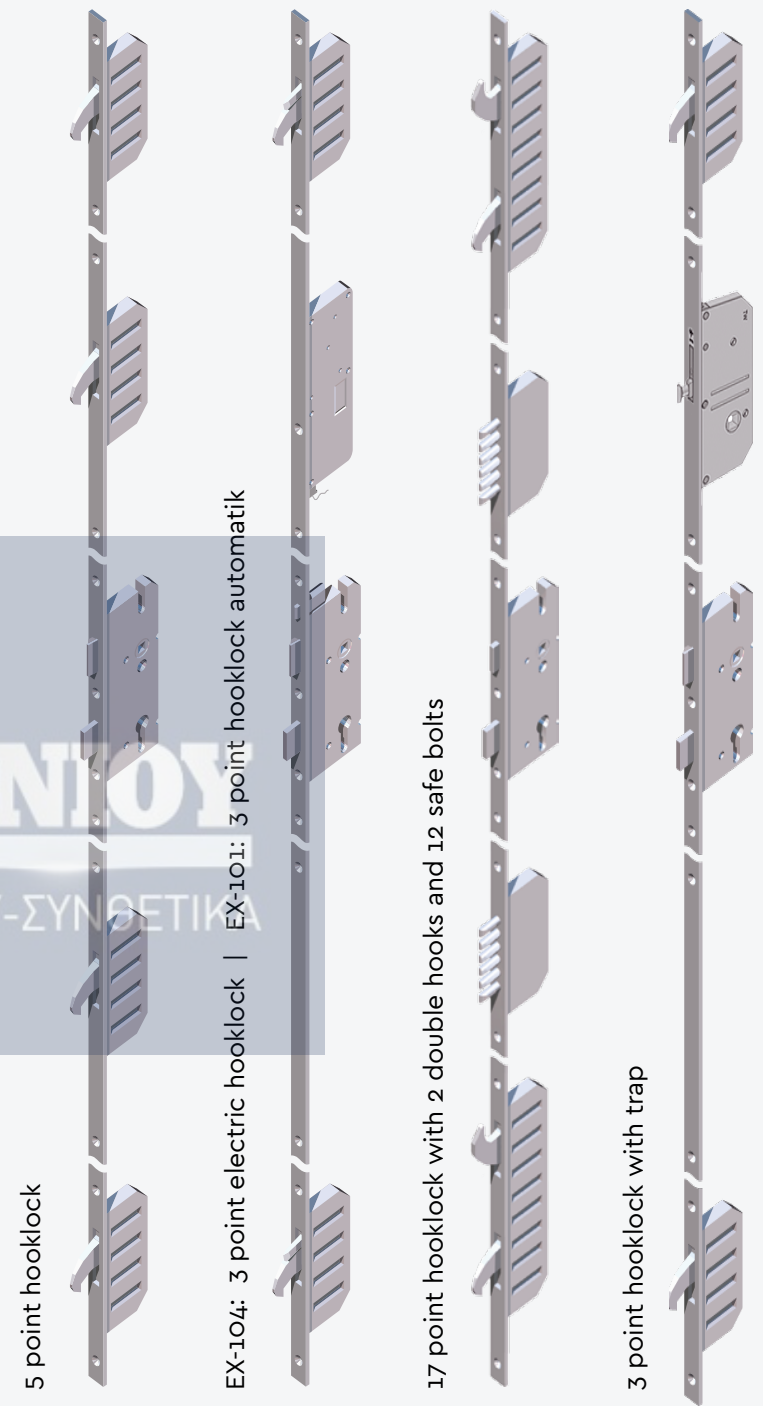

5 point hooklock

EX-104: 3 point electric hooklock | EX-101: 3 point hooklock automatic

17 point hooklock with 2 double hooks and 12 safe bolts

3 point hooklock with trap

EX-102

EX-104
EX-101

EX-103

EX-105

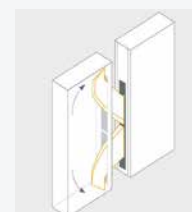
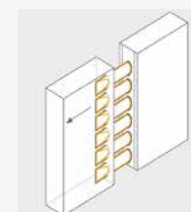



7.5 km. Veria - Naousa
GR 59132, P.O. Box 130
Veria, Greece

Tel: +30 23310 93025
+30 23310 93285
Fax: +30 23310 93085

www.verpan.gr
email: info@verpan.gr